



Southwire™

WEATHERPROOF

CATALOG

**BUILT FOR DURABILITY.
BUILT FOR RELIABILITY.
BUILT FOR WORK.™**

SOUTHWIRE.COM

WEATHERPROOF

Southwire weatherproof products provide rugged protection to the outdoor electrical wiring. Made with aluminum die-cast that is covered with powder coat paint to add layer of protection and engineered plastic with UV protection. Products are designed to meet the Underwriters Laboratories standards as well as NEC® electrical code.

Metallic Boxes & Covers
Nonmetallic Boxes & Covers
Metallic & Nonmetallic While in Use Covers
Lighting and Accessories

DIE-CAST ALUMINUM BOXES

SINGLE GANG BOXES

3 HOLE



WB1350



UL® Listed and 2011 NEC®
NEMA® 3R Compliant
NEMA FB 1

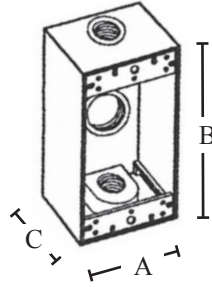

FEATURES

- 18.3 cubic inch capacity, WB13100 - 16.8 cubic inch capacity
- 1/2", 3/4" or 1" threaded hub
- Superior commercial quality die-cast metal construction
- Boxes include 2 closure plugs, grounding screws and mounting lugs
- Installation instructions included
- Gray, bronze and white

APPLICATIONS

- UL listed for wet locations
- For wall or pole mounting of outdoor outlets, switches or floodlights

STANDARD MATERIAL

- Copper free aluminum

STANDARD FINISH

- Premium powder coat finish

PART #	THREADED HUB	COLOR	MASTER QTY.	WEIGHT/ CASE (LBS.)	A	B	C
WB1350	1/2"	GRAY	25	15	2.81"	4.56"	2"
WB1350B	1/2"	BRONZE	25	15	2.81"	4.56"	2"
WB1350W	1/2"	WHITE	25	15	2.81"	4.56"	2"
WB1375	3/4"	GRAY	25	15	2.81"	4.56"	2"
WB1375B	3/4"	BRONZE	25	15	2.81"	4.56"	2"
WB1375W	3/4"	WHITE	25	15	2.81"	4.56"	2"
WB13100	1"	GRAY	25	13	2.81"	4.56"	2"

4 HOLE



WB1450



UL® Listed and 2011 NEC® and
NEMA® 3R Compliant

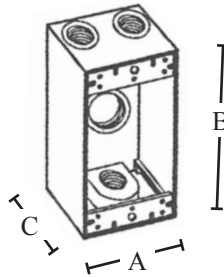

FEATURES

- 17 cubic inch capacity
- 1/2" or 3/4" threaded hub
- Superior commercial quality die-cast metal construction
- Boxes include closure plugs, grounding screws and mounting lugs
- Installation instructions included
- Gray, bronze and white

APPLICATIONS

- UL listed for wet locations
- For wall or pole mounting of outdoor outlets, switches or floodlights

STANDARD MATERIAL

- Copper free aluminum

STANDARD FINISH

- Premium powder coat finish

PART #	THREADED HUB	COLOR	MASTER QTY.	WEIGHT/ CASE (LBS.)	A	B	C
WB1450	1/2"	GRAY	25	14	2.81"	4.56"	2"
WB1450B	1/2"	BRONZE	25	14	2.81"	4.56"	2"
WB1450W	1/2"	WHITE	25	14	2.81"	4.56"	2"
WB1475	3/4"	GRAY	25	14	2.81"	4.56"	2"

WEATHERPROOF

DIE-CAST ALUMINUM BOXES

SINGLE GANG BOXES

5 HOLE



WB1550



UL® Listed and 2011 NEC® and NEMA® 3R Compliant

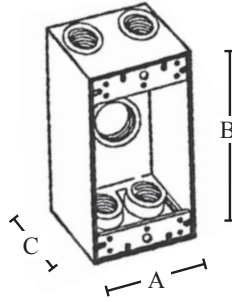

FEATURES

- 16.8 cubic inch capacity
- 1/2" or 3/4" threaded hub
- Superior commercial quality die-cast metal construction
- Boxes include closure plugs, grounding screws and mounting lugs
- Installation instructions included
- Gray

APPLICATIONS

- UL listed for wet locations
- For wall or pole mounting of outdoor outlets, switches or floodlights

STANDARD MATERIAL

- Copper free aluminum

STANDARD FINISH

- Premium powder coat finish

PART #	THREADED HUB	MASTER QTY.	WEIGHT/ CASE (LBS.)	A	B	C
WB1550	1/2"	25	13	2.81"	4.56"	2"
WB1575	3/4"	25	13	2.81"	4.56"	2"

5 HOLE SIDE OPENING



WB1550X



UL® Listed and 2011 NEC® and NEMA® 3R Compliant

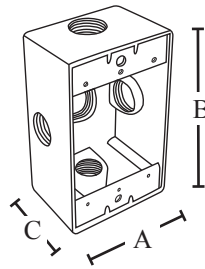

FEATURES

- 18.3 cubic inch capacity, WB1550X - 16.8 cubic inch capacity
- 1/2", 3/4" or 1" threaded hub
- Superior commercial quality die-cast metal construction
- Boxes include closure plugs, grounding screws and mounting lugs
- Installation instructions included
- Gray

APPLICATIONS

- UL listed for wet locations
- For wall or pole mounting of outdoor outlets, switches or floodlights

STANDARD MATERIAL

- Copper free aluminum

STANDARD FINISH

- Premium powder coat finish

PART #	THREADED HUB	MASTER QTY.	WEIGHT/ CASE (LBS.)	A	B	C
WB1550X	1/2"	25	13	2.81"	4.56"	2"
WB1575X	3/4"	25	13	2.81"	4.56"	2"
WB15100X	1"	25	13	2.81"	4.56"	2"

WEATHERPROOF

DIE-CAST ALUMINUM BOXES

SINGLE GANG BOXES

3 HOLE DEEP

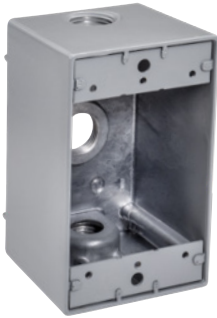

WDB1350



UL® Listed and 2011 NEC® and NEMA® 3R Compliant

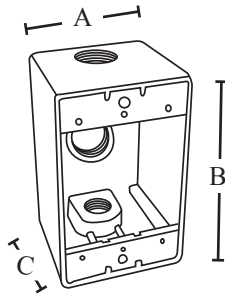

FEATURES

- 23.8 cubic inch capacity
- 1/2", 3/4" or 1" threaded hub
- Superior commercial quality die-cast metal construction
- Boxes include closure plugs, grounding screws and mounting lugs
- Installation instructions included
- Gray, bronze and white

APPLICATIONS

- UL listed for wet locations
- For wall or pole mounting of outdoor outlets, switches or floodlights

STANDARD MATERIAL

- Copper free aluminum

STANDARD FINISH

- Premium powder coat finish

PART #	THREADED HUB	COLOR	MASTER QTY.	WEIGHT/ CASE (LBS.)	A	B	C
WDB1350	1/2"	GRAY	20	16	2.81"	4.56"	2.62"
WDB1350B	1/2"	BRONZE	20	16	2.81"	4.56"	2.62"
WDB1350W	1/2"	WHITE	20	16	2.81"	4.56"	2.62"
WDB1375	3/4"	GRAY	20	16	2.81"	4.56"	2.62"
WDB1375B	3/4"	BRONZE	20	16	2.81"	4.56"	2.62"
WDB1375W	3/4"	WHITE	20	16	2.81"	4.56"	2.62"
WDB13100	1"	GRAY	20	16	2.81"	4.56"	2.62"

5 HOLE DEEP SIDE OPENING

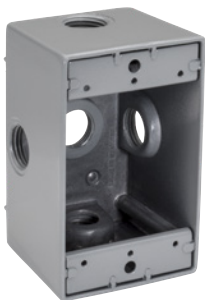

WDB1550X



UL® Listed and 2011 NEC® and NEMA® 3R Compliant

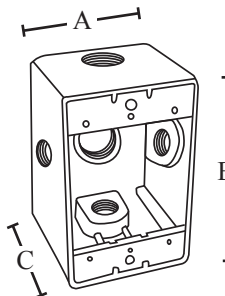

FEATURES

- 23.8 cubic inch capacity
- 1/2", 3/4" or 1" threaded hub
- Superior commercial quality die-cast metal construction
- Boxes include closure plugs, grounding screws and mounting lugs
- Installation instructions included
- Gray

APPLICATIONS

- UL listed for wet locations
- For wall or pole mounting of outdoor outlets, switches or floodlights

STANDARD MATERIAL

- Copper free aluminum

STANDARD FINISH

- Premium powder coat finish

PART #	THREADED HUB	MASTER QTY.	WEIGHT/ CASE (LBS.)	A	B	C
WDB1550X	1/2"	20	13	2.81"	4.56"	2.62"
WDB1575X	3/4"	20	13	2.81"	4.56"	2.62"
WDB15100X	1"	20	13	2.81"	4.56"	2.62"

WEATHERPROOF

DIE-CAST ALUMINUM BOXES

DOUBLE GANG BOXES

3 HOLE



WB2350



UL® Listed and 2011 NEC® and NEMA® 3R Compliant

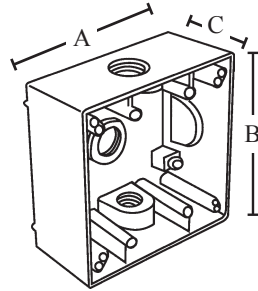

FEATURES

- 30 cubic inch capacity
- 1/2", 3/4" or 1" threaded hub
- Superior commercial quality die-cast metal construction
- Boxes include closure plugs, grounding screws and mounting lugs
- Installation instructions included
- Gray, bronze and white

APPLICATIONS

- UL listed for wet locations
- For wall or pole mounting of outdoor outlets, switches or floodlights

STANDARD MATERIAL

- Copper free aluminum

STANDARD FINISH

- Premium powder coat finish

PART #	THREADED HUB	COLOR	MASTER QTY.	WEIGHT/ CASE (LBS.)	A	B	C
WB2350	1/2"	GRAY	10	22	4.56"	4.56"	2"
WB2350B	1/2"	BRONZE	10	22	4.56"	4.56"	2"
WB2350W	1/2"	WHITE	10	22	4.56"	4.56"	2"
WB2375	3/4"	GRAY	10	22	4.56"	4.56"	2"
WB2375B	3/4"	BRONZE	10	22	4.56"	4.56"	2"
WB2375W	3/4"	WHITE	10	22	4.56"	4.56"	2"
WB23100	1"	GRAY	10	22	4.56"	4.56"	2"

4 HOLE



WB2450



UL® Listed and 2011 NEC® and NEMA® 3R Compliant

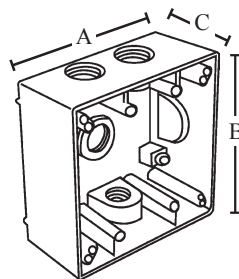

FEATURES

- 30 cubic inch capacity
- 1/2" or 3/4" threaded hub
- Superior commercial quality die-cast metal construction
- Boxes include closure plugs, grounding screws and mounting lugs
- Installation instructions included
- Gray

APPLICATIONS

- UL listed for wet locations
- For wall or pole mounting of outdoor outlets, switches or floodlights

STANDARD MATERIAL

- Copper free aluminum

STANDARD FINISH

- Premium powder coat finish

PART #	THREADED HUB	MASTER QTY.	WEIGHT/ CASE (LBS.)	A	B	C
WB2450	1/2"	10	21	4.56"	4.56"	2"
WB2475	3/4"	10	21	4.56"	4.56"	2"

WEATHERPROOF

DIE-CAST ALUMINUM BOXES

DOUBLE GANG BOXES

5 HOLE



WB2550



UL® Listed and 2011 NEC® and NEMA® 3R Compliant

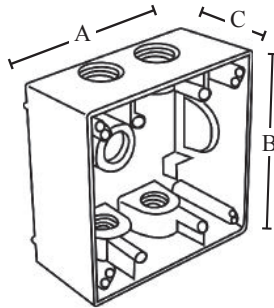

FEATURES

- 30 cubic inch capacity
- 1/2" or 3/4" threaded hub
- Superior commercial quality die-cast metal construction
- Boxes include closure plugs, grounding screws and mounting lugs
- Installation instructions included
- Gray

APPLICATIONS

- UL listed for wet locations
- For wall or pole mounting of outdoor outlets, switches or floodlights

STANDARD MATERIAL

- Copper free aluminum

STANDARD FINISH

- Premium powder coat finish

PART #	THREADED HUB	MASTER QTY.	WEIGHT/ CASE (LBS.)	A	B	C
WB2550	1/2"	10	20	4.56"	4.56"	2"
WB2575	3/4"	10	20	4.56"	4.56"	2"

7 HOLE



WB2750



UL® Listed and 2011 NEC® and NEMA® 3R Compliant

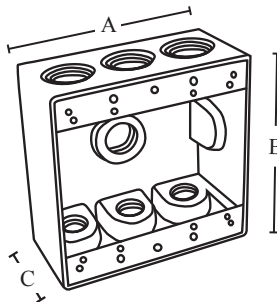

FEATURES

- 30 cubic inch capacity
- 1/2" or 3/4" threaded hub
- Superior commercial quality die-cast metal construction
- Boxes include closure plugs, grounding screws and mounting lugs
- Installation instructions included
- Gray

APPLICATIONS

- UL listed for wet locations
- For wall or pole mounting of outdoor outlets, switches or floodlights

STANDARD MATERIAL

- Copper free aluminum

STANDARD FINISH

- Premium powder coat finish

PART #	THREADED HUB	MASTER QTY.	WEIGHT/ CASE (LBS.)	A	B	C
WB2750	1/2"	10	20	4.56"	4.56"	2"
WB2775	3/4"	10	20	4.56"	4.56"	2"

WEATHERPROOF

DIE-CAST ALUMINUM BOXES

DOUBLE GANG BOXES

5 HOLE DEEP



WDB2550



UL® Listed and 2011 NEC® and NEMA® 3R Compliant

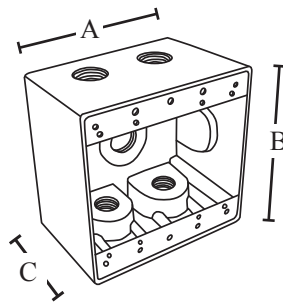

PART #	THREADED HUB	MASTER QTY.	WEIGHT/ CASE (LBS.)	A	B	C
WDB2550	1/2"	10	21	4.56"	4.56"	2.62"
WDB2575	3/4"	10	21	4.56"	4.56 "	2.62"
WDB25100	1"	10	21	4.56"	4.56"	2.62"

FEATURES

- 38.5 cubic inch capacity
- 1/2", 3/4" or 1" threaded hub
- Superior commercial quality die-cast metal construction
- Boxes include closure plugs, grounding screws and mounting lugs
- Installation instructions included
- Gray

APPLICATIONS

- UL listed for wet locations
- For wall or pole mounting of outdoor outlets, switches or floodlights

STANDARD MATERIAL

- Copper free aluminum

STANDARD FINISH

- Premium powder coat finish

5 HOLE SIDE OPENING



WB2550X



UL® Listed and 2011 NEC® and NEMA® 3R Compliant

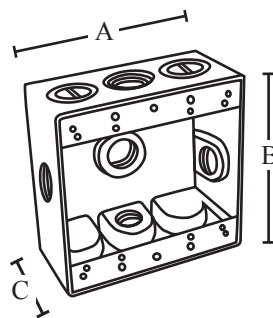

PART #	THREADED HUB	MASTER QTY.	WEIGHT/ CASE (LBS.)	A	B	C
WB2550X	1/2"	10	20	4.56"	4.56"	2"
WB2575X	3/4"	10	20	4.56"	4.56 "	2"
WB25100X	1"	10	20	4.56"	4.56"	2"

FEATURES

- 30 cubic inch capacity
- 1/2", 3/4" or 1" threaded hub
- Superior commercial quality die-cast metal construction
- Boxes include closure plugs, grounding screws and mounting lugs
- Installation instructions included
- Gray

APPLICATIONS

- UL listed for wet locations
- For wall or pole mounting of outdoor outlets, switches or floodlights

STANDARD MATERIAL

- Copper free aluminum

STANDARD FINISH

- Premium powder coat finish

WEATHERPROOF

DIE-CAST ALUMINUM BOXES

DOUBLE GANG BOXES

6 HOLE SIDE OPENING



WB2650X



UL® Listed and 2011 NEC® and NEMA® 3R Compliant

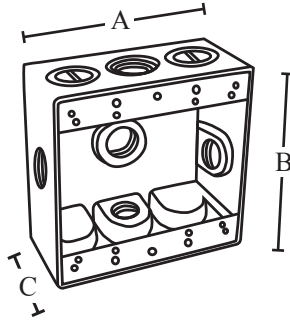

FEATURES

- 30 cubic inch capacity
- 1/2" or 3/4" threaded hub
- Superior commercial quality die-cast metal construction
- Boxes include closure plugs, grounding screws and mounting lugs
- Installation instructions included
- Gray

APPLICATIONS

- UL listed for wet locations
- For wall or pole mounting of outdoor outlets, switches or floodlights

STANDARD MATERIAL

- Copper free aluminum

STANDARD FINISH

- Premium powder coat finish

PART #	THREADED HUB	MASTER QTY.	WEIGHT/ CASE (LBS.)	A	B	C
WB2650X	1/2"	10	19	4.56"	4.56"	2"
WB2675X	3/4"	10	19	4.56"	4.56"	2"

7 HOLE SIDE OPENING



WB2775X



UL® Listed and 2011 NEC® and NEMA® 3R Compliant

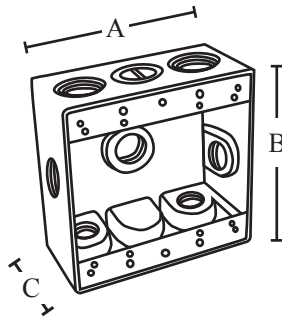

FEATURES

- 30 cubic inch capacity
- 1/2" or 3/4" threaded hub
- Superior commercial quality die-cast metal construction
- Boxes include closure plugs, grounding screws and mounting lugs
- Installation instructions included
- Gray

APPLICATIONS

- UL listed for wet locations
- For wall or pole mounting of outdoor outlets, switches or floodlights

STANDARD MATERIAL

- Copper free aluminum

STANDARD FINISH

- Premium powder coat finish

PART #	THREADED HUB	MASTER QTY.	WEIGHT/ CASE (LBS.)	A	B	C
WB2750X	1/2"	10	19	4.56"	4.56"	2"
WB2775X	3/4"	10	19	4.56"	4.56"	2"

WEATHERPROOF

DIE-CAST ALUMINUM BOXES

TRIPLE GANG BOXES

7 HOLE

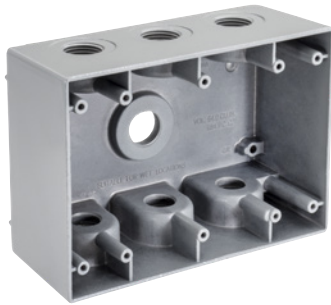

WB3750



UL® Listed and 2011 NEC® and NEMA® 3R Compliant

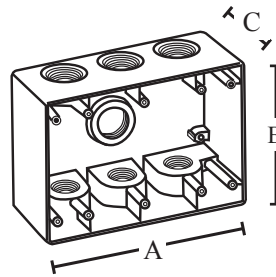

FEATURES

- 54 cubic inch capacity
- 1/2", 3/4" or 1" threaded hub
- Superior commercial quality die-cast metal construction
- Boxes include closure plugs, grounding screws and mounting lugs
- Installation instructions included
- Gray

APPLICATIONS

- UL listed for wet locations
- For wall or pole mounting of outdoor outlets, switches or floodlights

STANDARD MATERIAL

- Copper free aluminum

STANDARD FINISH

- Premium powder coat finish

PART #	THREADED HUB	MASTER QTY.	WEIGHT/ CASE (LBS.)	A	B	C
WB3750	1/2"	5	11	6.374"	4.56"	2.625"
WB3775	3/4"	5	10	6.374"	4.56"	2.625"
WB37100	1"	5	9	6.374"	4.56"	2.625"

WEATHERPROOF

DIE-CAST ALUMINUM COVERS

SINGLE GANG COVERS

10-IN-1 VERTICAL & HORIZONTAL MULTI-USE COVER



WC1V12



UL® Listed and 2011 NEC® and NEMA® 3R Compliant

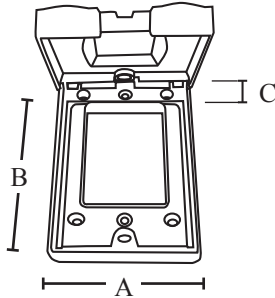

10-IN-1

ROUND
 1-3/8"
 1-5/8"

PART #	COLOR	MASTER QTY.	WEIGHT/ CASE (LBS.)	A	B	C
WC1V12	GRAY	20	22	2.81"	4.56"	.551"
WC1V12B	BRONZE	20	22	2.81"	4.56"	.551"
WC1V12W	WHITE	20	22	2.81"	4.56"	.551"

FEATURES

- Aluminum cast cover with spring loaded lid
- Can be mounted vertically or horizontally
- Heavy duty die-cast metal construction
- Weather seal gasket to block moisture
- Roomy interior provides space for switches
- Lockable
- Snap in configuration enables tool free installation
- Maximum corrosion resistant fabrication
- Gray, bronze and white

APPLICATIONS

- UL listed for wet locations
- For use with single gang outdoor device box

STANDARD MATERIAL

- Precision die-cast aluminum

STANDARD FINISH

- Premium powder coat finish

1 OR 3 HOLE RECTANGLE



WCR1150



WCR1350



UL® Listed and 2011 NEC® and NEMA® 3R Compliant

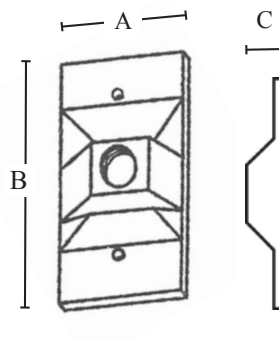

FEATURES

- 1 or 3 hole 1/2" threaded hub
- Includes gasket and screws
- Fits FS device boxes
- Superior commercial quality die-cast metal construction
- Installation instructions included
- Gray, bronze and white

APPLICATIONS

- UL listed for wet locations
- Fits FS device boxes

STANDARD MATERIAL

- Copper free aluminum

STANDARD FINISH

- Premium powder coat finish

PART #	# OF HOLES	COLOR	THREADED HUB	MASTER QTY.	WEIGHT/ CASE (LBS.)	A	B	C
WCR1150	1	GRAY	1/2"	50	14	2.79 "	4.55"	.99"
WCR1150W	1	WHITE	1/2"	50	14	2.79 "	4.55"	.99"
WCR1350	3	GRAY	1/2"	50	14	2.79 "	4.55"	.99"
WCR1350B	3	BRONZE	1/2"	50	14	2.79 "	4.55"	.99"
WCR1350W	3	WHITE	1/2"	50	14	2.79 "	4.55"	.99"

DIE-CAST ALUMINUM COVERS

SINGLE GANG COVERS

DUPLEX VERTICAL



WCV1DUP



UL® Listed and 2011 NEC® and NEMA®
3R Compliant

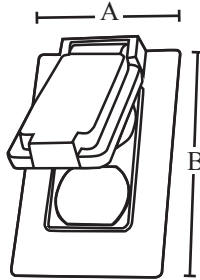

PART #	MASTER QTY.	WEIGHT/ CASE (LBS.)	A	B
WCV1DUP	50	25	2.81"	4.56"

FEATURES

- Aluminum cast cover with a spring loaded lid
- Weather seal gasket to block moisture
- Superior commercial quality die-cast metal construction
- Installation instructions included
- Gray

APPLICATIONS

- UL listed for wet locations
- For use with single gang outdoor device box

STANDARD MATERIAL

- Precision die-cast aluminum

STANDARD FINISH

- Premium powder coat finish

DUPLEX HORIZONTAL



WCH1DUPW



UL® Listed and 2011 NEC® and
NEMA® 3R Compliant
NEMA FB 1

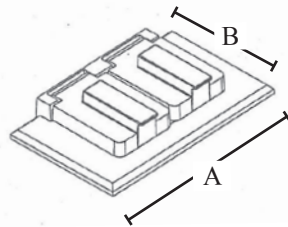

PART #	COLOR	MASTER QTY.	WEIGHT/ CASE (LBS.)	A	B
WCH1DUP	GRAY	50	35	4.56 "	2.81"
WCH1DUPB	BRONZE	50	35	4.56 "	2.81"
WCH1DUPW	WHITE	50	35	4.56 "	2.81"

FEATURES

- Heavy aluminum die-cast cover with a spring loaded lid
- Weather seal gasket to block moisture
- Superior commercial quality die-cast metal construction
- Installation instructions included
- Gray, bronze or white

APPLICATIONS

- UL listed for wet locations
- Will fit all duplex receptacles in single outlet boxes

STANDARD MATERIAL

- Precision die-cast aluminum

STANDARD FINISH

- Premium powder coat finish

WEATHERPROOF

NONMETALLIC MULTI-USE COVERS

18-IN-1 VERTICAL & HORIZONTAL 1-GANG FLAT COVERS



P1GFC-C



P1GFC-G



P1GFC-W

FEATURES

- Easy to install to electrical junction box
- Vertical and horizontal mount option
- Lockable for 1/4" shackles padlock
- Various adapter options for multiple wiring device configurations, 18-in-1
- Includes stainless steel mounting screws
- Preinstalled weatherproof gasket

APPLICATIONS

- UL listed for damp locations
- Provides superior protection for wiring devices

STANDARD MATERIAL

- High-impact polycarbonate with UV protection

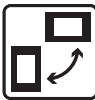

ROUND
1-1/4"
1-3/8"
1-9/16"
1-5/8"



PART #	COLOR	CASE QTY.	WEIGHT/ CASE (LBS.)	A	B	C
P1GFC-C	CLEAR	8	2	3.81	5.38	1.24
P1GFC-G	GRAY	8	2	3.81	5.38	1.24
P1GFC-W	WHITE	8	2	3.81	5.38	1.24

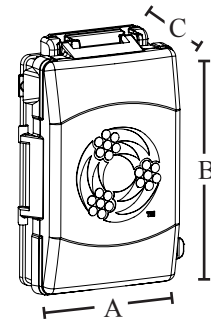

WEATHERPROOF

NONMETALLIC MULTI-USE COVERS

40-IN-1 2-GANG FLAT COVERS



P2GFC-C



P2GFC-G



P2GFC-W



FEATURES

- Easy to install to electrical junction box
- Lockable for 1/4" shackles padlock
- Various adapter options for multiple wiring device configurations, 40-in-1
- Includes stainless steel mounting screws
- Preinstalled weatherproof gasket

APPLICATIONS

- UL listed for damp locations
- Provides superior protection for wiring devices

STANDARD MATERIAL

- High-impact polycarbonate with UV protection



40-IN-1 **ROUND** | 1-1/4" 1-3/4" | 1-3/8" 2-1/8" | 1-9/16" 2-1/4" | 1-5/8" 2-7/16" | 1-11/16"

PART #	COLOR	CASE QTY.	WEIGHT/ CASE (LBS.)	A	B	C
P2GFC-C	CLEAR	6	2.4	5.4	5.05	1.24
P2GFC-W	GRAY	6	2.4	5.4	5.05	1.24
P2GFC-G	WHITE	6	2.4	5.4	5.05	1.24

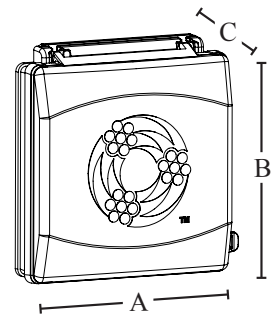

WEATHERPROOF

DIE-CAST ALUMINUM COVERS

SINGLE GANG COVERS

RECEPTACLE SWITCH



WCV11



UL® Listed and 2011 NEC® and NEMA® 3R Compliant

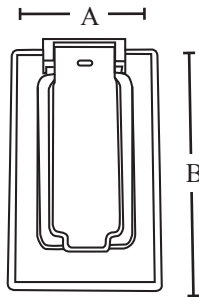

PART #	MASTER QTY.	WEIGHT/ CASE (LBS.)	A	B
WCV11	50	16	2.77"	4.52"

FEATURES

- Heavy aluminum die-cast cover with a spring loaded lid
- Weather seal gasket to block moisture
- Superior commercial quality die-cast metal construction
- Installation instructions included
- Gray

APPLICATIONS

- UL listed for wet locations
- Will fit 1.406" diameter receptacle in single outlet box

STANDARD MATERIAL

- Precision die-cast aluminum

STANDARD FINISH

- Premium powder coat finish

HORIZONTAL GFCI



WCH1GFI



UL® Listed and 2011 NEC® and NEMA® 3R Compliant

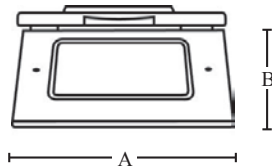

PART #	COLOR	MASTER QTY.	WEIGHT/ CASE (LBS.)	A	B
WCH1GFI	GRAY	50	20	4.56"	2.81"
WCH1GFIW	WHITE	50	20	4.56"	2.81"

FEATURES

- Heavy aluminum die-cast cover with a spring loaded lid
- Weather seal gasket to block moisture
- Superior commercial quality die-cast metal construction
- Installation instructions included
- Gray and white

APPLICATIONS

- UL listed for wet locations
- For use with single gang outdoor device box

STANDARD MATERIAL

- Precision die-cast aluminum

STANDARD FINISH

- Premium powder coat finish

WEATHERPROOF

DIE-CAST ALUMINUM COVERS

SINGLE GANG COVERS

VERTICAL GFCI



WCV1GFI



UL® Listed and 2011 NEC® and NEMA® 3R Compliant

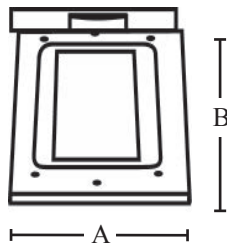

FEATURES

- Heavy aluminum die-cast cover with a spring loaded lid
- Weather seal gasket to block moisture
- Superior commercial quality die-cast metal construction
- Installation instructions included
- Gray and white

APPLICATIONS

- UL listed for wet locations
- For use with single gang outdoor device box

STANDARD MATERIAL

- Precision die-cast aluminum

STANDARD FINISH

- Premium powder coat finish

PART #	COLOR	MASTER QTY.	WEIGHT/ CASE (LBS.)	A	B
WCV1GFI	GRAY	50	20	2.81"	4.56"
WCV1GFIW	WHITE	50	20	2.81"	4.56"

VERTICAL TOGGLE SWITCH HEAVY DUTY COVER



WSC1VHD



UL® Listed and 2011 NEC® and NEMA® 3R Compliant

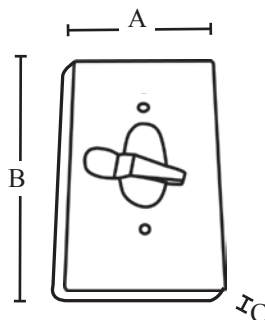

FEATURES

- Designed to fit over a toggle light switch and mounted in a weatherproof box
- Weather seal gasket to block moisture
- Superior commercial quality die-cast metal construction
- Installation instructions included
- Gray

APPLICATIONS

- UL listed for wet locations
- For use with single gang outdoor device box
- NEMA 3R compliant – resistant to rain, ice, and snow

STANDARD MATERIAL

- Precision die-cast aluminum

STANDARD FINISH

- Premium powder coat finish

PART #	MASTER QTY.	WEIGHT/ CASE (LBS.)	A	B	C
WSC1VHD	25	7	2.81"	4.57"	.63"

WEATHERPROOF

DIE-CAST ALUMINUM COVERS

SINGLE GANG COVERS

20A/30A RECEPTACLE
30A/50A RECEPTACLE



WCV11.625



UL® Listed and 2011 NEC® and
NEMA® 3R Compliant

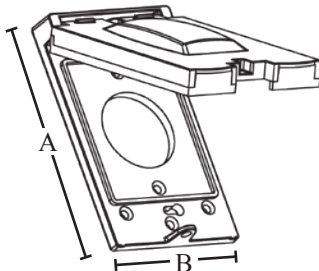

PART #	MASTER QTY.	WEIGHT/ CASE (LBS.)	A	B
WCV11.625	50	16	4.57"	2.80"
WCV12.125	50	16	4.57"	2.80"

FEATURES

- Heavy aluminum die-cast cover with a spring loaded lid
- Weather seal gasket to block moisture
- Superior commercial quality die-cast metal construction
- Installation instructions included
- Gray

APPLICATIONS

- UL listed for wet locations
- For use with single gang outdoor device box

STANDARD MATERIAL

- Precision die-cast aluminum

STANDARD FINISH

- Premium powder coat finish

BLANK



WC1B



UL® Listed and 2011 NEC® and
NEMA® 3R Compliant

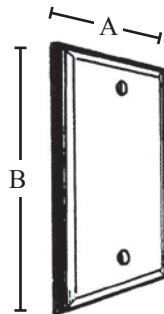

PART #	COLOR	MASTER QTY.	WEIGHT/ CASE (LBS.)	A	B
WC1B	GRAY	100	5	2.77"	4.54"
WC1BB	BRONZE	100	5	2.77"	4.54"
WC1BW	WHITE	100	5	2.77"	4.54"

FEATURES

- Weather seal gasket to block moisture
- Installation instructions included
- Gray, bronze and white

APPLICATIONS

- UL listed for wet locations
- For use with single gang outdoor device box

STANDARD MATERIAL

- Steel

WEATHERPROOF

DIE-CAST ALUMINUM COVERS

DOUBLE GANG COVERS

DUPLEX



WCV2DUP



UL® Listed and 2011 NEC® and NEMA® 3R Compliant

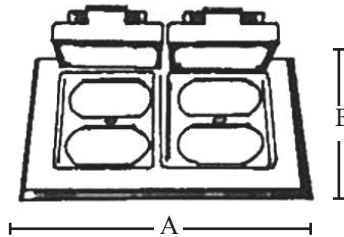

FEATURES

- Precision die-cast aluminum cover with a spring loaded lid
- Weather seal gasket to block moisture
- Superior commercial quality die-cast metal construction
- Installation instructions included
- Gray

APPLICATIONS

- UL listed for wet locations
- For use with double gang outdoor device box

STANDARD MATERIAL

- Precision die-cast aluminum

STANDARD FINISH

- Premium powder coat finish

PART #	MASTER QTY.	WEIGHT/ CASE (LBS.)	A	B
WCV2DUP	25	15	4.54"	4.54"

DUPLEX & SWITCH



WCV2SDUP



UL® Listed and 2011 NEC® and NEMA® 3R Compliant

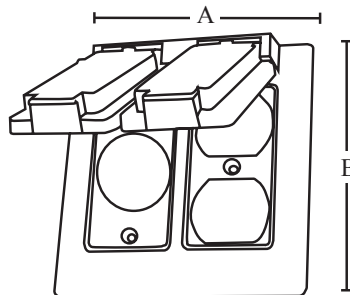

FEATURES

- Precision die-cast aluminum cover with a spring loaded lid
- Weather seal gasket to block moisture
- Superior commercial quality die-cast metal construction
- Installation instructions included
- Gray

APPLICATIONS

- UL listed for wet locations
- For use with double gang outdoor device box

STANDARD MATERIAL

- Precision die-cast aluminum

STANDARD FINISH

- Premium powder coat finish

PART #	MASTER QTY.	WEIGHT/ CASE (LBS.)	A	B
WCV2SDUP	25	16	4.54"	4.54"

WEATHERPROOF

DIE-CAST ALUMINUM COVERS

DOUBLE GANG COVERS

15 AMP SWITCH



WCV21515



UL® Listed and 2011 NEC® and NEMA® 3R Compliant

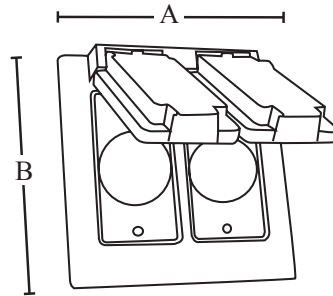

FEATURES

- Aluminum cast cover with a spring loaded lid
- Opening diameter 1.406" (2)
- Weather seal gasket to block moisture
- Superior commercial quality die-cast metal construction
- Installation instructions included
- Gray

APPLICATIONS

- UL listed for wet locations
- For use with double gang outdoor device box

STANDARD MATERIAL

- Precision die-cast aluminum

STANDARD FINISH

- Premium powder coat finish

PART #	MASTER QTY.	WEIGHT/ CASE (LBS.)	A	B
WCV21515	25	16	4.54"	4.54"

5-IN-1 COMBO COVER TOGGLE SWITCH



WC25GF1



UL® Listed and 2011 NEC® and NEMA® 3R Compliant

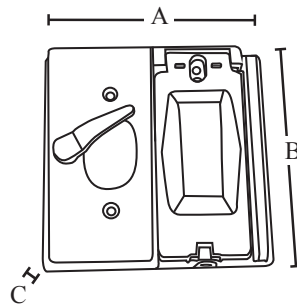

FEATURES

- Aluminum cast cover with a spring loaded lid with polycarbonate inserts
- Lockable design
- Pre-installed adhesive gasket
- Superior commercial quality die-cast metal construction
- Installation instructions included
- NEMA 3R compliant
- Gray

APPLICATIONS

- UL listed for wet locations
- For use with double gang outdoor device box

STANDARD MATERIAL

- Copper free aluminum

STANDARD FINISH

- Premium powder coat finish

PART #	MASTER QTY.	WEIGHT/ CASE (LBS.)	A	B	C
WC25GF1	12	7	4.57"	4.63"	.63"

WEATHERPROOF

DIE-CAST ALUMINUM COVERS

DOUBLE GANG COVERS

DUPLEX-GFCI

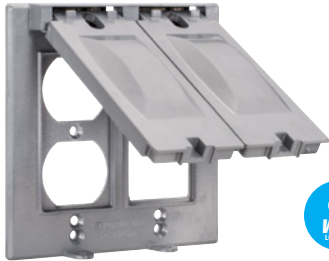

WCV2DUPGFI



UL® Listed and 2011 NEC® and NEMA® 3R Compliant

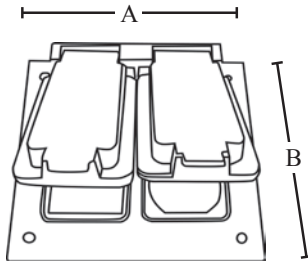

PART #	MASTER QTY.	WEIGHT/ CASE (LBS.)	A	B
WCV2DUPGFI	25	12	4.54"	4.54"

FEATURES

- Die-cast aluminum cover with a spring loaded lid
- Weather seal gasket to keep moisture out
- Superior commercial quality die-cast metal construction
- Installation instructions included
- Gray

APPLICATIONS

- UL listed for wet locations
- For use with double gang outdoor device box

STANDARD MATERIAL

- Precision die-cast aluminum

STANDARD FINISH

- Premium powder coat finish

VERTICAL-GFCI



WCV2GFI



UL® Listed and 2011 NEC® and NEMA® 3R Compliant

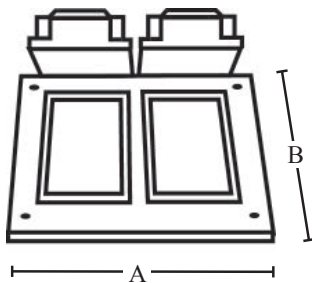

PART #	MASTER QTY.	WEIGHT/ CASE (LBS.)	A	B
WCV2GFI	50	35	4.54"	4.54"

FEATURES

- Precision die-cast aluminum cover with a spring loaded lid
- Weather seal gasket to block moisture
- Superior commercial quality die-cast metal construction
- Installation instructions included
- Gray

APPLICATIONS

- UL listed for wet locations
- For use with double gang outdoor device box

STANDARD MATERIAL

- Precision die-cast aluminum

STANDARD FINISH

- Premium powder coat finish

WEATHERPROOF

DIE-CAST ALUMINUM COVERS

DOUBLE GANG COVERS

TOGGLE SWITCH HEAVY DUTY



WSC22HD



UL® Listed and 2011 NEC® and NEMA® 3R Compliant

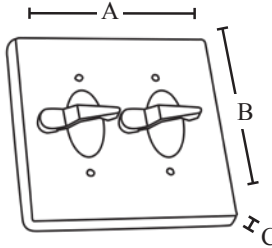

PART #	MASTER QTY.	WEIGHT/ CASE (LBS.)	A	B	C
WSC22HD	12	7	4.57"	4.63"	.63"

FEATURES

- Designed to fit over a toggle light switch and mounted in a weatherproof box
- Polycarbonate inserts
- Weather seal gasket to block moisture
- Superior commercial quality die-cast metal construction
- Installation instructions included
- NEMA 3R compliant
- Gray

APPLICATIONS

- UL listed for wet locations
- For use with double gang outdoor device box
- Can be used in NEMA 3R application (resistant to rain, ice, and snow)

STANDARD MATERIAL

- Precision die-cast aluminum

STANDARD FINISH

- Premium powder coat finish

20/50 AMP POWER OUTLET



WCV22125



UL® Listed and 2011 NEC® and NEMA® 3R Compliant

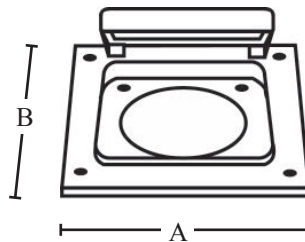

PART #	MASTER QTY.	WEIGHT/ CASE (LBS.)	A	B	HOLE DIAMETER
WCV22125	8	7	4.54"	4.54"	2.125"
WCV2264	8	7	4.54"	4.54"	2.64"

FEATURES

- Aluminum cast cover with a spring loaded lid
- Weather seal gasket to block moisture
- Installation instructions included
- Gray

APPLICATIONS

- UL listed for wet locations
- For use with double gang outdoor device box

STANDARD MATERIAL

- Copper free aluminum

STANDARD FINISH

- Premium powder coat finish

WEATHERPROOF

DIE-CAST ALUMINUM COVERS

DOUBLE GANG COVERS

16-IN-1 VERTICAL MULTI-USE COVER



WC2225

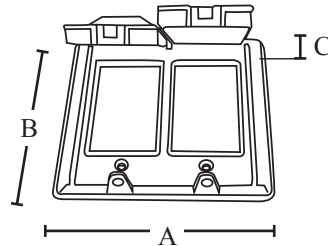

UL® Listed and 2011 NEC® and NEMA® 3R Compliant

FEATURES

- Aluminum cast multi-use cover with spring loaded lid
- Weather seal gasket to block moisture
- Superior commercial quality die-cast metal construction
- Installation instructions included
- Gray, bronze and white

APPLICATIONS

- UL listed for wet locations
- For receptacles in damp or wet locations
- For use with double gang outdoor device box

STANDARD MATERIAL

- Precision die-cast aluminum

STANDARD FINISH

- Premium powder coat finish

PART #	COLOR	MASTER QTY.	WEIGHT/ CASE (LBS.)	A	B	C
WC2225	GRAY	10	17	4.56"	4.56"	.551"
WC2225B	BRONZE	10	17	4.56"	4.56"	.551"
WC2225W	WHITE	10	17	4.56"	4.56"	.551"

BLANK



WC2B

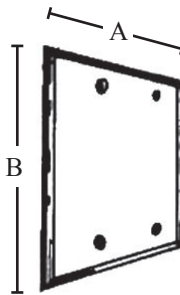

UL® Listed and 2011 NEC® and NEMA® 3R Compliant

FEATURES

- Aluminum cast cover
- Weather seal gasket to block moisture
- Installation instructions included
- Superior commercial quality die-cast metal construction
- Natural, bronze and white

APPLICATIONS

- UL listed for wet locations
- For use with double gang outdoor device box

STANDARD MATERIAL

- Natural - Stamped aluminum
- Bronze and White - Steel

PART #	COLOR	MASTER QTY.	WEIGHT/ CASE (LBS.)	A	B
WC2B	SILVER	100	11	4.62"	4.57"
WC2BB	BRONZE	100	11	4.62"	4.57"
WC2BW	WHITE	100	11	4.62"	4.57"

WEATHERPROOF

DIE-CAST ALUMINUM COVERS

TRIPLE GANG COVERS

64-IN-1 VERTICAL MULTI-USE COVER



WC3325

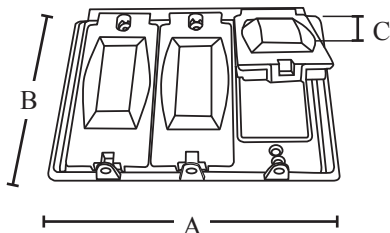

UL® Listed and 2011 NEC® and NEMA® 3R Compliant

FEATURES

- Aluminum cast multi-use cover with a spring loaded lid
- Weather seal gasket to block moisture
- Installation instructions included
- Gray

APPLICATIONS

- UL listed for wet locations
- For use with triple gang outdoor device box

STANDARD MATERIAL

- Copper free aluminum

STANDARD FINISH

- Premium powder coat finish

PART #	MASTER QTY.	WEIGHT/ CASE (LBS.)	A	B	C
WC3325	5	6	6.338"	4.57"	.551"

BLANK



WC3B

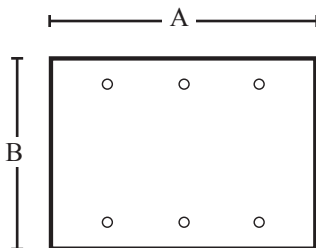

UL® Listed and 2011 NEC® and NEMA® 3R Compliant

FEATURES

- Aluminum cast cover
- Weather seal gasket to block moisture
- Superior commercial quality die-cast metal construction
- Installation instructions included
- Gray

APPLICATIONS

- UL listed for wet locations
- For use with triple gang outdoor device box
- NEMA 3R compliant – resistant to rain, ice and snow

STANDARD MATERIAL

- Natural - Stamped aluminum

PART #	MASTER QTY.	WEIGHT/ CASE (LBS.)	A	B
WC3B	20	8	6.338"	4.57"

WEATHERPROOF

NONMETALLIC WHILE IN-USE COVERS

18-IN-1 EXTRA DUTY 1-GANG IN-USE COVER



1GIU-C



1GIU-G



1GIU-W



PART #	COLOR	CASE QTY.	WEIGHT/CASE (LBS.)	A	B	C
1GIU-C	CLEAR	8	3.0	3.75"	5.25"	3.375"
1GIU-G	GRAY	4	1.5	3.75"	5.25"	3.375"
1GIU-W	WHITE	4	1.5	3.75"	5.25"	3.375"

FEATURES

- Extra Duty Rated Cover for Wet and Damp Locations
- Polycarbonate with UV protection provides durability
- Easy to mount to electrical junction box
- Vertical and Horizontal mount option
- Lockable for 1/4" shackle padlock

APPLICATIONS

- UL listed for wet locations
- Extra Duty non metallic while in-use covers are designed for use whenever weatherproof protection is required while an outlet is in use
- Provides superior protection for residential, industrial, and commercial electrical wiring devices

STANDARD MATERIAL

- High impact polycarbonate
- Attached Gasket and Stainless-Steel mounting hardware included
- Various adapter options for multitude wiring devices configurations, 18-in-1
- Extra Duty Rated

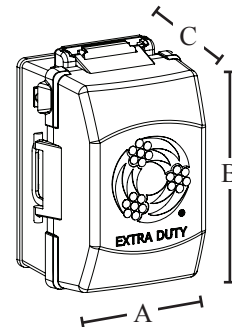

WEATHERPROOF

SINGLE GANG IN-USE COVER - VERTICAL OR HORIZONTAL

14-IN-1 EXTRA DUTY IN-USE COVER



WCIU1D



FEATURES

- Mounts vertically or horizontally
- Pre-installed adhesive gasket
- Swivel device adapter enables tool free installation
- Snap in adapters enable tool free installation
- Lockable to prevent accidental disconnects
- Meets 2014 NEC article 406.8 (B) (1)
- NEMA 3R compliant
- Gray with clear cover

APPLICATIONS

- UL listed for wet locations
- For use with duplex receptacles, GFCI, toggle, 1-3/8", 1-5/8", 1-11/16" & 2-1/8" round

STANDARD MATERIAL

- High impact polycarbonate



UL® Listed and 2011 NEC® and NEMA® 3R Compliant

14-IN-1 | | | | | | **ROUND** | 1-3/8" | 1-5/8" | 1-11/16" | 2-1/8"

PART #	MASTER QTY.	WEIGHT/ CASE (LBS.)	A	B	C DEPTH
WCIU1D	24	14	2.81"	4.56"	3.50"

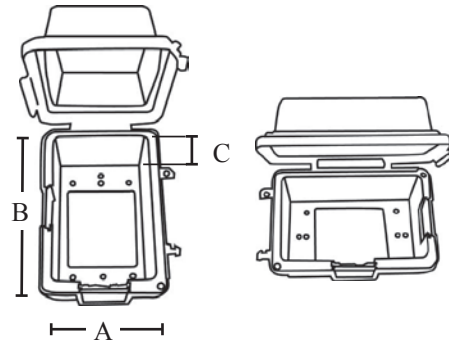

WEATHERPROOF

METALLIC WHILE IN-USE COVERS

9-IN-1 EXTRA DUTY 1-GANG IN-USE COVER



M1GVIU-G



M1GVIU-W



M1GVIU-B



M1GHIU-G

FEATURES

- Extra duty rated cover for wet and damp locations
- Made with durable die-cast aluminum with powder coat protection
- Easy to install to electrical junction box and to use
- Lockable to secure

APPLICATIONS

- UL Listed for wet locations
- Extra duty metallic in-use covers are designed for use whenever weatherproof protection is required while an outlet is in use
- Provide superior protection for residential, industrial, and commercial electrical wiring devices
- Attached weatherproof gasket and stainless-steel mounting hardware included
- Various adapter options for multiple wiring devices configurations 9-in-1



9-in-1

ROUND
 1-1/4"
 1-3/8"
 1-9/16"
 1-5/8"



MODEL #	MOUNTING ORIENTATION	COLOR	CASE QTY	WEIGHT/CASE (LBS)	A	B	C
M1GVIU-G	VERTICAL	GRAY	6	7	4.2"	5.7"	3.5"
M1GVIU-W	VERTICAL	WHITE	6	7	4.2"	5.7"	3.5"
M1GVIU-B	VERTICAL	BRONZE	6	7	4.2"	5.7"	3.5"
M1GHIU-G	HORIZONTAL	GRAY	4	4.7	5.9"	4"	3.5"



WEATHERPROOF

NONMETALLIC WHILE IN-USE COVERS

40-IN-1 EXTRA DUTY 2-GANG IN-USE COVER



2GIU-C

2GIU-G



2GIU-W

FEATURES

- Extra duty rated cover for wet and damp locations
- Polycarbonate with UV protection provides durability
- Easy to mount to electrical junction box
- Lockable for 1/4" shackle padlock

APPLICATIONS

- UL listed for wet locations
- Extra duty non metallic while in-use covers are designed for use whenever weatherproof protection is required while an outlet is in use
- Provides superior protection for residential, industrial, and commercial electrical wiring devices

STANDARD MATERIAL

- High impact polycarbonate
- Attached gasket and stainless-steel mounting hardware included
- Various adapter options for multitude wiring devices configurations, 40-in-1
- Extra duty rated



40-IN-1

ROUND

1-1/4"	1-3/4"
1-3/8"	2-1/8"
1-9/16"	2-1/4"
1-5/8"	2-7/16"
1-11/16"	

PART #	COLOR	CASE QTY.	WEIGHT/ CASE (LBS.)	A	B	C
2GIU-C	CLEAR	6	3.0	5.55"	5.45"	3.375"
2GIU-G	GRAY	4	2.0	5.55"	5.45"	3.375"
2GIU-W	WHITE	4	2.0	5.55"	5.45"	3.375"

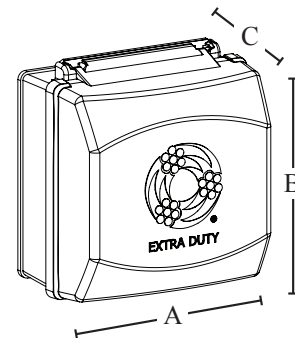

WEATHERPROOF

METALLIC WHILE IN-USE COVERS

40-IN-1 EXTRA DUTY 2-GANG IN-USE COVER



M2GIU-G



M2GIU-W



FEATURES

- Extra duty rated cover for wet and damp locations
- Made with durable die-cast aluminum with powder coat protection
- Easy to install to electrical junction box and to use
- Lockable to secure

APPLICATIONS

- UL Listed for wet locations
- Extra duty metallic in-use covers are designed for use whenever weatherproof protection is required while an outlet is in use
- Provide superior protection for residential, industrial, and commercial electrical wiring devices
- Attached weatherproof gasket and stainless-steel mounting hardware included
- Various adapter options for multiple wiring device configurations 40-in-1



40-IN-1   **ROUND**

1-1/4"	1-3/4"
1-3/8"	2-1/8"
1-9/16"	2-1/4"
1-5/8"	2-7/16"
1-11/16"	

MODEL #	COLOR	CASE QTY	WEIGHT/CASE (LBS)	A	B	C
M2GIU-G	GRAY	2	3	5.94"	5.73"	3.5"
M2GIU-W	WHITE	2	3	5.94"	5.73"	3.5"

WEATHERPROOF

ROUND COVERS

1, 2, OR 3 HOLE



WRC150



WRC350



WRC250



UL® Listed and 2011 NEC® and NEMA® 3R Compliant

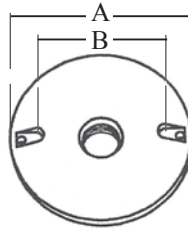

FEATURES

- NPT threads
- Weather seal gasket blocks moisture
- Installation instructions included
- Gray, bronze and white

APPLICATIONS

- UL listed for wet locations
- For use with round outdoor device box

STANDARD MATERIAL

- Precision die-cast aluminum

STANDARD FINISH

- Premium powder coat finish

PART #	# HOLES	THREADED HUB	COLOR	MASTER QTY.	WEIGHT/ CASE (LBS.)	A	B	C
WRC150	1	1/2"	GRAY	50	9	4.50"	3.50"	8.75"
WRC150B*	1	1/2"	BRONZE	50	9	4.50"	3.50"	8.75"
WRC250	2	1/2"	GRAY	50	9	4.50"	3.50"	8.75"
WRC350	3	1/2"	GRAY	50	9	4.50"	3.50"	8.75"
WRC350B*	3	1/2"	BRONZE	50	9	4.50"	3.50"	8.75"
WRC150W**	1	1/2"	WHITE	50	9	4.50"	3.50"	8.75"
WRC250W**	2	1/2"	WHITE	50	10	4.50"	3.50"	8.75"
WRC350W**	3	1/2"	WHITE	50	10	4.50"	3.50"	8.75"

BLANK



WRCB

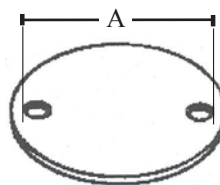

FEATURES

- Weather seal gasket and screws to keep out moisture
- Will fit round outlet boxes
- Installation instructions included
- Natural finish

APPLICATIONS

- UL listed for wet locations
- For use with round outdoor device box

STANDARD MATERIAL

- Stamped aluminum

CERTIFICATIONS

- UL Standard: UL 514A - UL514D
- Fed. Spec: W-C-586D, AA-50563
- NEMA: FB 1-2014, NEMA 3R
- 2011 NEC®

PART #	MASTER QTY.	WEIGHT/ CASE (LBS.)	A
WRCB	50	8	4.08"

4" ROUND BOX

5 HOLE



WRB1550W



UL® Listed and 2011 NEC® and NEMA® 3R Compliant

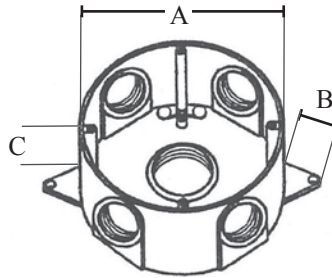

FEATURES

- 15.8 cubic inch capacity
- Includes 4 closure plugs and grounding screws
- 1/2" or 3/4" threaded hub
- For wall or ceiling mounting
- Installation instructions included
- Gray, bronze and white

APPLICATIONS

- UL listed for wet locations
- For use with all round outlet box and lampholder covers

STANDARD MATERIAL

- Copper free aluminum

STANDARD FINISH

- Premium powder coat finish

PART #	THREADED HUB	COLOR	MASTER QTY.	WEIGHT/ CASE (LBS.)	A	B	C DEPTH
WRB1550	1/2"	GRAY	25	14	4.31"	.65"	1.58"
WRB1550B	1/2"	BRONZE	25	14	4.31"	.65"	1.58"
WRB1550W	1/2"	WHITE	25	14	4.31"	.65"	1.58"
WRB1575	3/4"	GRAY	25	14	4.31"	.65"	1.58"
WRB1575W	3/4"	WHITE	25	14	4.31"	.65"	1.58"

4" ROUND EXTENSIONS

4 HOLE



WRB450EXT



UL® Listed and 2011 NEC® and NEMA® 3R Compliant

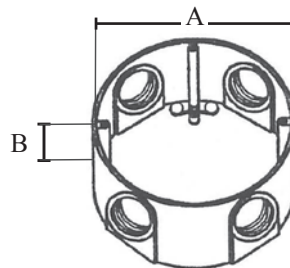

FEATURES

- Corrosion resistant die-cast construction
- 1/2" or 3/4" threaded hub
- Installation instructions included

APPLICATIONS

- UL listed for wet locations
- Expands cubic capacity and enables flush finish

STANDARD MATERIAL

- Copper free aluminum

PART #	THREADED HUB	MASTER QTY.	WEIGHT/ CASE (LBS.)	A	B
WRB450EXT	1/2"	10	6	4.31"	1.58"
WRB475EXT	3/4"	10	6	4.31"	1.58"

WEATHERPROOF

SINGLE GANG EXTENSION RECTANGLE



WB1EXT

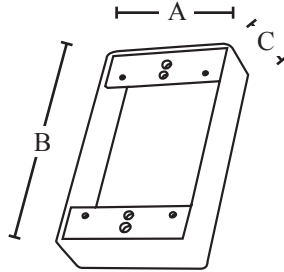

FEATURES

- Installation instructions included
- Superior commercial quality die-cast metal construction

APPLICATIONS

- Expands cubic capacity and enables flush finish

STANDARD MATERIAL

- Copper free aluminum

STANDARD FINISH

- Premium powder coat finish

PART #	MASTER QTY.	WEIGHT/ CASE (LBS.)	A	B	C DEPTH
WB1EXT	25	6	2.81"	4.56"	1"

4 HOLE



WB1450EXT



UL® Listed and 2011 NEC® and NEMA® 3R Compliant

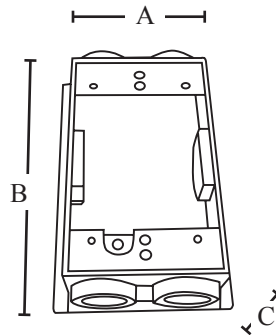

FEATURES

- 1/2" or 3/4" threaded hub
- Installation instructions included

APPLICATIONS

- UL listed for wet locations
- Expands cubic capacity and enables flush finish

STANDARD MATERIAL

- Copper free aluminum

STANDARD FINISH

- Premium powder coat finish

PART #	THREADED HUB	MASTER QTY.	WEIGHT/ CASE (LBS.)	A	B	C DEPTH
WB1450EXT	1/2"	25	18	3.464"	5.236"	1.575"
WB1475EXT	3/4"	25	16	3.464"	5.236"	1.575"

SINGLE GANG EXTENSIONS

6 HOLE



WB1650EXT



UL® Listed and 2011 NEC® and NEMA® 3R Compliant

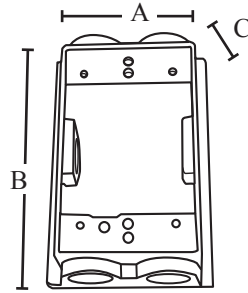

FEATURES

- NPT threads
- 1/2" or 3/4" threaded hub
- Installation instructions included

APPLICATIONS

- UL listed for wet locations
- Expands cubic capacity and enables flush finish

STANDARD MATERIAL

- Copper free aluminum

STANDARD FINISH

- Premium powder coat finish

PART #	THREADED HUB	MASTER QTY.	WEIGHT/ CASE (LBS.)	A	B	C
WB1650EXT	1/2"	25	16	3.464"	5.236"	1.575"
WB1675EXT	3/4"	25	14	3.464"	5.236"	1.575"

DOUBLE GANG EXTENSION

SQUARE



WB2EXT

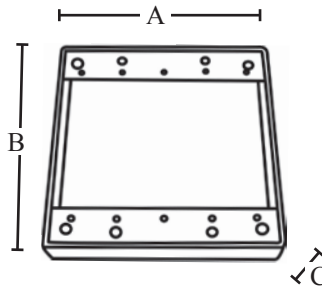

FEATURES

- Installation instructions included
- Superior commercial quality die-cast metal construction

APPLICATIONS

- Expands cubic capacity and enables flush finish

STANDARD MATERIAL

- Copper free aluminum

STANDARD FINISH

- Premium powder coat finish

PART #	MASTER QTY.	WEIGHT/ CASE (LBS.)	A	B	C
WB2EXT	25	25	4.56"	4.56"	1"

WEATHERPROOF

PAR LAMP HOLDERS



WPAR50W

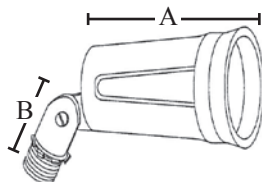

PART #	SIZE	COLOR	MASTER QTY.	WEIGHT/ CASE (LBS.)	A	B
WPAR50	1/2"	GRAY	50	22	2.57"	2"
WPAR50B	1/2"	BRONZE	50	22	2.57"	2"
WPAR50W	1/2"	WHITE	50	22	2.57"	2"

FEATURES

- Medium base
- 1/2" locknut and gasket included
- 150 Watts max, Par38
- Swivels 180°
- Gray, bronze and white

APPLICATIONS

- UL listed for wet locations

STANDARD MATERIAL

- Copper free aluminum

STANDARD FINISH

- Premium powder coat finish

CLOSURE PLUGS



WP75



WP50PL

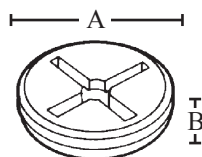

PART #	SIZE	COLOR	MASTER QTY.	WEIGHT/ CASE (LBS.)	A	B
WP50	1/2"	GRAY	100	2	.79"	.33"
WP75	3/4"	GRAY	50	2	1"	.30"
WP100	1"	GRAY	25	2	1.23"	.28"
PLASTIC						
WP50PL	1/2"	GRAY	100	1	.79"	.33"
WP50PLB	1/2"	BRONZE	50	1	.79"	.33"
WP50PLW	1/2"	WHITE	50	1	.79"	.33"
WP75PL	3/4"	GRAY	50	1	1"	.30"

FEATURES

- 1/2" - 1" closure plugs
- Gray, bronze and white

APPLICATIONS

- UL listed for wet locations
- Safely seal off unused hubs in metallic outlet boxes

STANDARD MATERIAL

- Cast aluminum with powder coat finish or plastic

STANDARD FINISH

- Cast aluminum – premium powder coat finish

BOX HOLDER



WPBH50

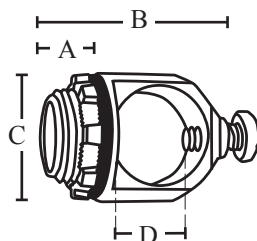

PART #	SIZE	MASTER QTY.	WEIGHT/ CASE (LBS.)	A	B	C	D
WPBH50	1/2"	25	40	.38	1.55"	1.125"	.86"

FEATURES

- Can be used as an external means of support to meet the requirements of 2011 NEC Section 314-23
- Gray

APPLICATIONS

- Stubs up electrical boxes, and fire alarms with rigid pipe between bar joists
- Installation is easy—simply insert the box support into the electrical box. The entire assembly is held secure with a 1/2" rigid steel conduit or water pipe

STANDARD MATERIAL

- Corrosion resistant die-cast zinc

RECEPTACLE COVER

SINGLE



1317

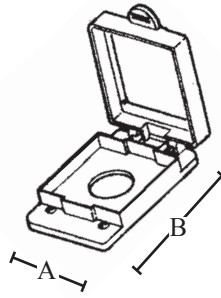

FEATURES

- Spring loaded lid; weather seal gasket
- Weatherproof cover when closed
- Cover must be matched to the capacity size of the receptacle

APPLICATIONS

- Fits a single receptacle; prevents damage from water and other elements

STANDARD MATERIAL

- PVC

PART #	SIZE	HOLE DIAMETER	MASTER QTY.	WEIGHT/ CASE (LBS.)	A	B
1317	15 AMP	1.375	10	3	2.8125"	4.5625"
1318	20 AMP	1.625	10	3	2.8125"	4.5625"
1319	30 AMP	1.722	10	3	2.8125"	4.5625"
1320	50 AMP	2.187	10	3	2.8125"	4.5625"

GFI RECEPTACLE COVER

SINGLE



1321

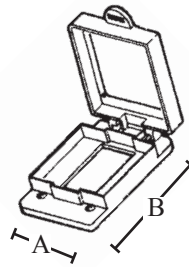

FEATURES

- Spring loaded lid; weather seal gasket
- Weatherproof cover when closed
- Cover must be matched to the capacity size of the receptacle

APPLICATIONS

- Fits a single gang FS type box and covers a standard ground fault interrupter receptacle

STANDARD MATERIAL

- PVC

PART #	MASTER QTY.	WEIGHT/ CASE (LBS.)	A	B
1321	10	3	2.8125"	4.5625"

DUPLEX RECEPTACLE COVER

SINGLE



1323

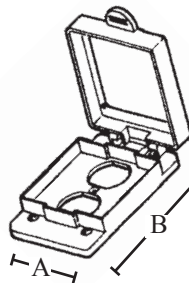

FEATURES

- Spring loaded lid; weather seal gasket
- Weatherproof cover when closed
- Cover must be matched to the capacity size of the receptacle

APPLICATIONS

- Fits a single gang FS type box and covers a standard ground fault interrupter receptacle

STANDARD MATERIAL

- PVC

PART #	MASTER QTY.	WEIGHT/ CASE (LBS.)	A	B
1323	10	3	2.8125"	4.5625"

WEATHERPROOF

TOGGLE SWITCH COVER

SINGLE



1316

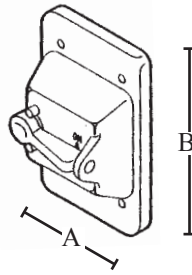

PART #	MASTER QTY.	WEIGHT/ CASE (LBS.)	A	B
1316	10	2	2.8125"	4.5625"

FEATURES

- Weatherproof cover fits a single gang FS type box

APPLICATIONS

- Toggle arm operates a standard 115 volt single or double pole switch which is completely enclosed

STANDARD MATERIAL

- PVC

PLUNGER SWITCH COVER

SINGLE



1326

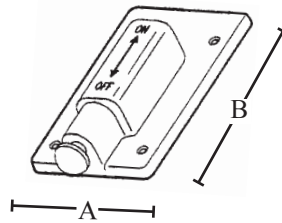

PART #	MASTER QTY.	WEIGHT/ CASE (LBS.)	A	B
1326	10	3	2.8125"	4.5625"

FEATURES

- Weatherproof cover fits a single gang FS type box

APPLICATIONS

- Plunger operates a standard single or double pole 115 volt switch which is completely enclosed

STANDARD MATERIAL

- PVC

SWITCH COVER

SINGLE



1315

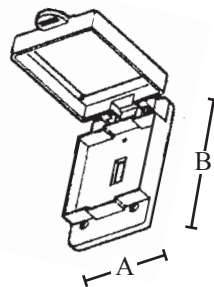

PART #	MASTER QTY.	WEIGHT/ CASE (LBS.)	A	B
1315	10	3	2.8125"	4.5625"

FEATURES

- Weatherproof cover when closed

APPLICATIONS

- Fits a single gang FS type box and covers a single or double pole standard 115 volt switch

STANDARD MATERIAL

- PVC

WEATHERPROOF

BLANK COVER

SINGLE



1313TZ

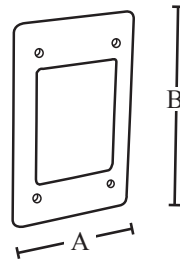

PART #	MASTER QTY.	WEIGHT/ CASE (LBS.)	A	B
1313TZ	50	6	2.875"	4.5625"

FEATURES

- Companion to Topaz single PVC boxes
- Rust proof; corrosion resistant

APPLICATIONS

- For use with a single gang FS type box

STANDARD MATERIAL

- PVC

DOUBLE



1314

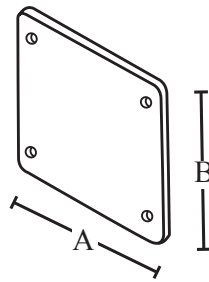

PART #	MASTER QTY.	WEIGHT/ CASE (LBS.)	A	B
1314	25	5	4.5625"	4.5625"

FEATURES

- Companion to Topaz double PVC boxes
- Rust proof; corrosion resistant

APPLICATIONS

- For use with a double gang FS type box

STANDARD MATERIAL

- PVC

WEATHERPROOF

TWO TOGGLE SWITCH COVER

DOUBLE



1324

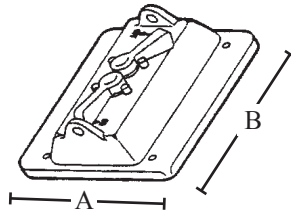

FEATURES

- Weatherproof when closed
- Easy to access toggle arms operate the enclosed switches

APPLICATIONS

- Fits double gang FB box that encloses 2 single or double pole 115 volt standard switches

STANDARD MATERIAL

- PVC

PART #	MASTER QTY.	WEIGHT/CASE (LBS.)	A	B
1324	10	3	4.5625"	4.5625"

GFCI & TOGGLE SWITCH COVER

DOUBLE



1325



FEATURES

- Spring loaded lid; weather seal gasket
- Weatherproof cover when closed
- Cover must be matched to the capacity size of the receptacle

APPLICATIONS

- Fits a double gang FS type box and covers a standard ground fault interrupter receptacle
- Covers 1 single or double pole 115 volt switch & 1 standard 115 volt duplex receptacle

STANDARD MATERIAL

- PVC

PART #	MASTER QTY.	WEIGHT/CASE (LBS.)
1325	10	3

WEATHERPROOF

FD TYPE BOX

BLANK - SINGLE



1281

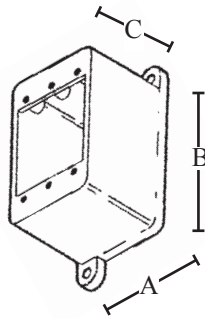

PART #	MASTER QTY.	WEIGHT/ CASE (LBS.)	A	B	C
1281	10	4	2.875"	4.5625"	2.375"

FEATURES

- Mounting feet enable easy installation
- Accommodates standard covers and accessories

APPLICATIONS

- Commonly used for tele-communications applications
- Use for terminations where hub requirements vary

STANDARD MATERIAL

- PVC

FSE TYPE BOXES

SINGLE



1282

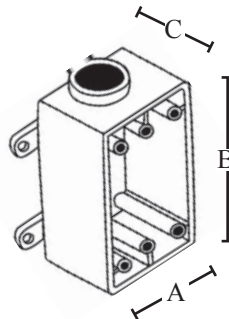

PART #	SIZE	MASTER QTY.	WEIGHT/ CASE (LBS.)	A	B	C
1282	1/2"	10	5	2.875"	4.5625"	2.375"
1283	3/4"	10	5	2.875"	4.5625"	2.375"
1284	1"	10	4	2.875"	4.5625"	2.375"

FEATURES

- Mounting feet enable easy installation
- Accommodates standard covers and accessories
- Surface mounted electrical box which has only one conduit entrance hub with no outlet hub

APPLICATIONS

- Use for dead end terminations

STANDARD MATERIAL

- PVC

FSC TYPE BOXES

SINGLE



1288

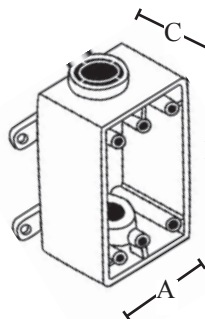

PART #	SIZE	MASTER QTY.	WEIGHT/ CASE (LBS.)	A	B	C
1288	1/2"	10	5	2.875"	4.5625"	2.375"
1289	3/4"	10	5	2.875"	4.5625"	2.375"
1290	1"	10	5	2.875"	4.5625"	2.375"

FEATURES

- Mounting feet enable easy installation
- Accommodates standard covers and accessories
- Surface mounted electrical box which has one conduit entrance hub in each of the two short walls of the box

APPLICATIONS

- Use for straight line conduit runs, splices and through terminations
- Uses single gang electrical device cover

STANDARD MATERIAL

- PVC

WEATHERPROOF

FSS TYPE BOXES

SINGLE



1294

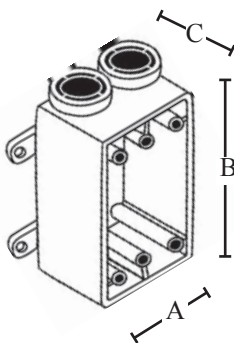

PART #	SIZE	MASTER QTY.	WEIGHT/ CASE (LBS.)	A	B	C
1294	1/2"	10	5	2.875"	4.5625"	2.375"
1295	3/4"	10	5	2.875"	4.5625"	2.375"
1296	1"	10	4	2.875"	4.5625"	2.375"

FEATURES

- Mounting feet enable easy installation
- Accommodates standard covers and accessories
- Surface mounted electrical box which has two conduit entrance hubs on one short wall of the box only

APPLICATIONS

- Use for straight line conduit runs, splices and for multiple dead end circuit terminations
- Ideal when additional support is required for stub ups
- Uses single gang electrical device cover

STANDARD MATERIAL

- PVC

FSCC TYPE BOXES

SINGLE



1301TZ

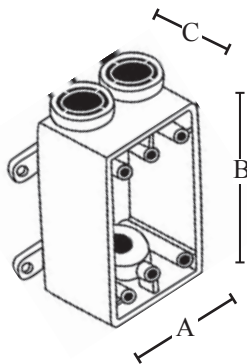

PART #	SIZE	MASTER QTY.	WEIGHT/ CASE (LBS.)	A	B	C
1301TZ	1/2"	10	5	2.875"	4.5625"	2.375"
1302TZ	3/4"	10	5	2.875"	4.5625"	2.375"
1303	1"	10	4	2.875"	4.5625"	2.375"

FEATURES

- Mounting feet enable easy installation
- Accommodates standard covers and accessories
- Surface mounted electrical box that has two conduit entrance hubs in one wall of the box and one hub in the opposite wall

APPLICATIONS

- Use for straight line conduit runs, splices and multiple through terminations
- Ideal when additional support is required for stub ups
- Uses single gang electrical device cover

STANDARD MATERIAL

- PVC

WEATHERPROOF

FDC TYPE BOXES

SINGLE



1307

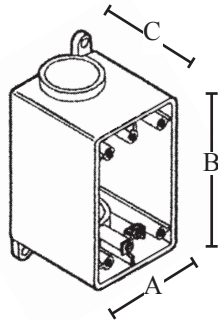

FEATURES

- Surface mounted electrical box with grounding lug has one conduit entrance hub in each of the two short walls of the box

APPLICATIONS

- Use for straight line conduit runs and splices
- Uses single gang electrical device cover

STANDARD MATERIAL

- PVC

PART #	SIZE	MASTER QTY.	WEIGHT/ CASE (LBS.)	A	B	C
1307	1/2"	10	6	2.875"	4.5625"	3"
1308	3/4"	10	6	2.875"	4.5625"	3"
1309	1"	10	5	2.875"	4.5625"	3"

FDS TYPE BOXES

SINGLE



1310

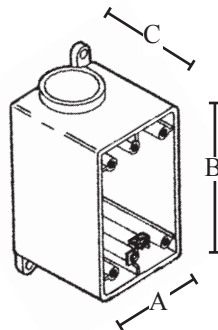

FEATURES

- Surface mounted electrical box with grounding lug has one conduit hub on short wall side

APPLICATIONS

- Use for straight line conduit runs and splices
- Uses single gang electrical device cover

STANDARD MATERIAL

- PVC

PART #	SIZE	MASTER QTY.	WEIGHT/ CASE (LBS.)	A	B	C
1310	1/2"	10	4	2.875"	4.5625"	3"
1311	3/4"	10	6	2.875"	4.5625"	3"
1312	1"	10	5	2.875"	4.5625"	3"

WEATHERPROOF

FSE TYPE BOXES

DOUBLE

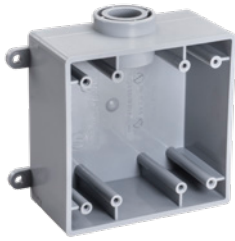

1285

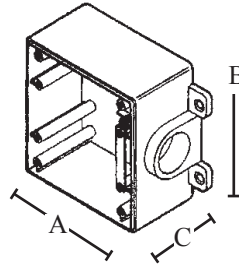

PART #	SIZE	MASTER QTY.	WEIGHT/ CASE (LBS.)	A	B	C
1285	1/2"	5	3	4.5625"	4.5625"	2.375"
1286	3/4"	5	3	4.5625"	4.5625"	2.375"
1287	1"	5	3	4.5625"	4.5625"	2.375"

FEATURES

- Mounting feet enable easy installation
- Accommodates standard covers and accessories
- Surface mounted electrical box which has only one conduit entrance hub with no outlet hub

APPLICATIONS

- Use for dead end terminations
- Uses double gang device covers

STANDARD MATERIAL

- PVC

FSC TYPE BOXES

DOUBLE



1291

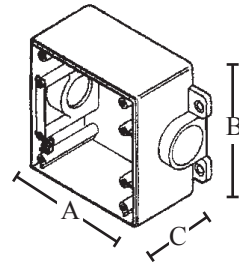

PART #	SIZE	MASTER QTY.	WEIGHT/ CASE (LBS.)	A	B	C
1291	1/2"	5	4	4.5625"	4.5625"	2.375"
1292	3/4"	5	4	4.5625"	4.5625"	2.375"
1293	1"	5	3	4.5625"	4.5625"	2.375"

FEATURES

- Mounting feet enable easy installation
- Accommodates standard covers and accessories
- Surface mounted electrical box which has one conduit entrance hub in each of the two opposite walls of the box

APPLICATIONS

- Use for straight line conduit runs, splices and through terminations
- Uses double gang electrical device cover

STANDARD MATERIAL

- PVC

WEATHERPROOF

FSS TYPE BOXES

DOUBLE



1297

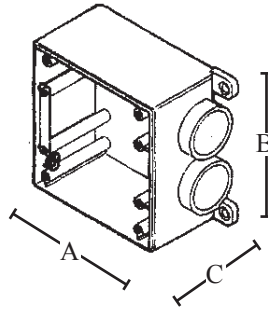

PART #	SIZE	MASTER QTY.	WEIGHT/ CASE (LBS.)	A	B	C
1297	1/2"	5	4	4.5625"	4.5625"	2.375"
1298	3/4"	5	3	4.5625"	4.5625"	2.375"
1299	1"	5	3	4.5625"	4.5625"	2.375"

FEATURES

- Detachable mounting feet enable easy installation
- Accommodates standard covers and accessories
- Surface mounted electrical box which has two conduit entrance hubs on one wall of the box only

APPLICATIONS

- Use for straight line conduit runs, splices and for multiple dead end circuit terminations
- Ideal when additional support is required for stub ups
- Uses double gang electrical device cover

STANDARD MATERIAL

- PVC

FSCC TYPE BOXES

DOUBLE



1304

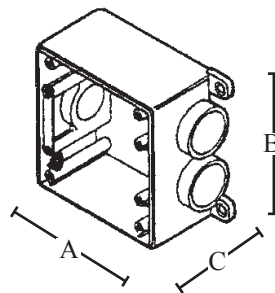

PART #	SIZE	MASTER QTY.	WEIGHT/ CASE (LBS.)	A	B	C
1304	1/2"	5	4	4.5625"	4.5625"	2.375"
1305	3/4"	5	4	4.5625"	4.5625"	2.375"
1306	1"	5	3	4.5625"	4.5625"	2.375"

FEATURES

- Mounting feet enable easy installation
- Accommodates standard covers and accessories
- Surface mounted electrical box that has two conduit entrance hubs in one wall of the box and one hub in the opposite wall

APPLICATIONS

- Use for straight line conduit runs, splices and multiple through terminations
- Ideal when additional support is required for stub ups
- Uses double gang electrical device cover

STANDARD MATERIAL

- PVC

WEATHERPROOF

JUNCTION BOXES



1221

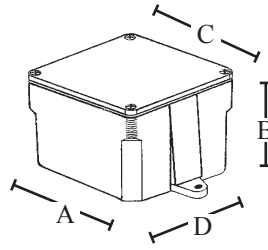

FEATURES

- NEMA 3 rated where indicated
- A surface mounted enclosure without entrance hubs which allows multiple conduits to be connected and wire splices made within

APPLICATIONS

- Appropriate round hole for conduit entrance must be cut
- Male adapters or box adapters may be used to secure conduit to the box
- May be concrete encased or buried (not warranted or listed to be watertight for all circumstances)

STANDARD MATERIAL

- PVC
- Screws - Zinc plated steel

PART #	INSIDE DIMENSION	MASTER QTY.	WEIGHT/CASE (LBS.)	A	B	C	D
1221*	4" x 4" x 2"	10	7	4.375"	2.375"	4.375"	4.375"
1222*	4" x 4" x 4"	10	11	4.25"	4.375"	4.25"	4.25"
1223*	4" x 4" x 6"	10	15	4.25"	6.3125"	4.25"	4.25"
1224*	5" x 5" x 2"	10	9	5.25"	2.3125"	5.25"	5.25"
1225TZ*	6" x 6" x 4"	10	23	6.375"	4.375"	6.75"	6.375"
1226*	6" x 6" x 6"	5	14	6.375"	6.3125"	6.6875"	6.375"
1227*	8" x 8" x 4"	5	18	8.50"	4.50"	8.875"	8.50"
1228	8" x 8" x 6"	4	18	8.3125"	6.4375"	9"	8.3125"
1229*	8" x 8" x 7"	4	21	8.75"	7.75"	9"	8.75"
1230TZ*	12" x 12" x 4"	2	14	12.50"	4.4375"	12.875"	12.50"
1231*	12" x 12" x 6"	2	18	12.375"	6.50"	12.875"	12.375"
1232*	16" x 14" x 6"	1	12	16.75"	6.75"	17.125" x 15.125"	14.75"
1233**	24" x 18" x 8"	1	23	24.125"	8.25"	24.25" x 18.75"	18.25"
1234†	24" x 24" x 8"	1	36	24.25"	8.25"	24.1875"	24.25"
1235TZ†	36" x 24" x 8"	1	34	24.25"	8.25"	24.25" x 36.25"	36.25"

* NEMA 3 rated

** UL listed with only a Type 1 NEMA rating

† Not UL listed

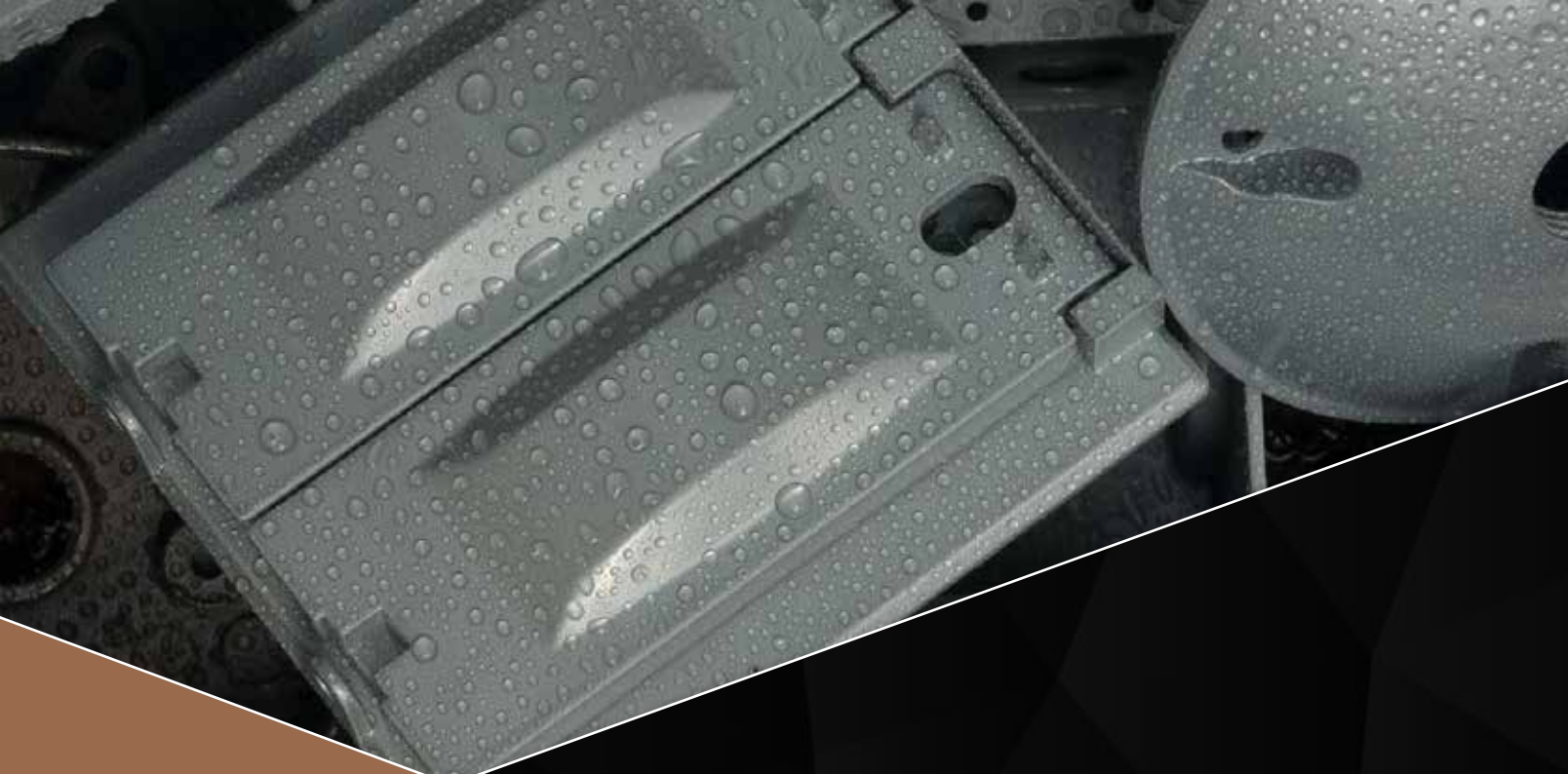

Southwire™

WEATHERPROOF

CATALOG

get social with us:



[/SOUTHWIRETOOLS](#)



[/SOUTHWIRE-COMPANY](#)



[@SOUTHWIRETOOLS](#)



[@SOUTHWIRE](#)



SCAN TO LEARN MORE

WWW.SOUTHWIRE.COM | 1-855-SWT00LS

All Trademarks or Registered Trademarks (TM/®) are owned or licensed by Southwire Company.
Any other TM/®- Trademark or Registered Trademark of Southwire Company.