



Southwire™

HANGING & SUPPORT CATALOG



**BUILT FOR DURABILITY.
BUILT FOR RELIABILITY.
BUILT FOR WORK.™**

SOUTHWIRE.COM

HANGING & SUPPORT

PRODUCTS FOR EVERY APPLICATION

Southwire™ is pleased to offer a comprehensive line of Hanging and Support, including over 300 Spring Steel items, manufactured to our standards of superior quality.

Our assortment offers versatile solutions in a variety of sizes used at the stud level of construction to hang, support or mount anything from wire and cable, conduit to rods, to strut, and steel boxes.

Spring Steel Fasteners & Supports create time savings and efficiency on the job site, empowering electricians to demonstrate skill and quality of work through a display of neatly organized cables and wire.

ABOUT SOUTHWIRE™ GEOSEAL™

The Southwire™ GEOSEAL™ anti-corrosion coating is a high-performance, water-based and chrome-free, zinc and aluminum flake technology that protects our Spring Steel Fasteners & Supports from corrosion. Free of toxic metals such as chromium, nickel, cadmium, lead, barium and mercury, the metallic silver coating is odorless and contractor friendly. The GEOSEAL™ coating is salt spray-tested over hundreds of hours to ensure excellent adhesion as well as damage and chemical resistance.

CABLE/ CONDUIT

**Secures cable and conduit to
electrical support systems**

BEAM ATTACHMENT

ROD/WIRE HANGERS

STRUT CLAMPS

CLAMPS AND CLIPS

BRACKETS AND HANGERS

COMBINATION BOX/CONDUIT

PIPE FITTINGS

CABLE TO FLANGE CLIP



RMX58TZ

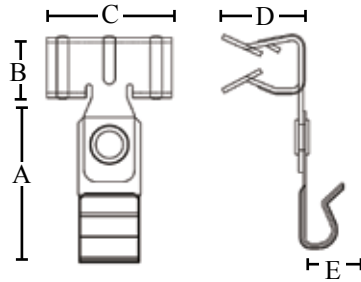

FEATURES

- Supports 14-2 to 12-2 NM cables
- Accommodates flange thickness of 5/16" - 1/2"
- Hammer-on installation

APPLICATION

- Supports nonmetallic sheathed cable to flanges

MATERIAL/FINISH

- Spring Steel/GEOSEAL™

CERTIFICATIONS

- UL Standard: UL 2239



PART #	BOX QTY.	A	B	C	D	E
RMX58TZ	100	1.44"	.606"	1.26"	.866"	.331"

CABLE CLIPS



SC2DTZ

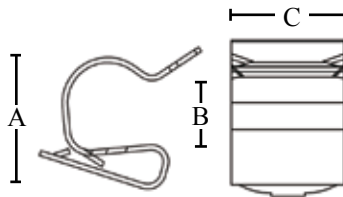

FEATURES

- Easy hammer-on installation
- Supports cables to beams with no additional hardware

APPLICATION

- Cable clips easily snap on to flanges for cable positioning, no load rating listed

MATERIAL/FINISH

- Spring Steel/GEOSEAL™

CERTIFICATIONS

- UL Standard: UL 2239



PART #	FLANGE THICKNESS	CABLE DIAMETER	BOX QTY.	A	B	C
SC2DTZ	1/16" - 3/16"	.472" - .551"	100	.744"	.343"	.551"
SC2FTZ	1/16" - 3/16"	.748" - .945"	100	1.02"	.356"	.551"
SC4DTZ	3/16" - 9/32"	.472" - .551"	100	.744"	.343"	.551"
SC4ETZ	3/16" - 9/32"	.591" - .709"	100	.645"	.335"	.551"

No load rating, for positioning only

SNAP-CLOSE CONDUIT TO FLANGE CLAMP

BOTTOM MOUNT



812M24TZ



812M58TZ



812M912TZ

FEATURES

- Hammer-on installation
- Snap-close conduit clip pivots 360°
- Secures EMT, rigid and aluminum conduit to beams

APPLICATION

- Conduit flange mount snap-close clamps support EMT and rigid conduit from beams.
- Equipped with a rotatable joint allows the snap-close conduit clip to rotate 360° to position conduit in different directions

MATERIAL/FINISH

- Spring Steel/GEOSEAL™

CERTIFICATIONS

- UL Standard: UL 2239

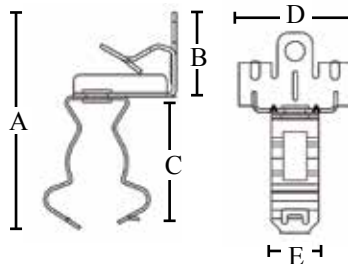

HANGING AND SUPPORT

PART #	FLANGE THICKNESS	STATIC LOAD (LBS.)	EMT/RIGID SIZE	FMC SIZE	MC/AC SIZE	BOX QTY.	A	B	C	D	E
6M24TZ	1/8" – 1/4"	75	---	3/8"	14-2 – 12-3	100	2.74"	1.06"	1.68"	1.50"	.63"
812M24TZ	1/8" – 1/4"	75	1/2" & 3/4"	---	---	100	3.11"	1.06"	2.05"	1.50"	.63"
16M24TZ	1/8" – 1/4"	75	1"	---	---	100	3.58"	1.06"	2.52"	1.50"	.63"
20M24TZ	1/8" – 1/4"	75	1-1/4"	---	---	50	4.02"	1.06"	2.96"	1.50"	.63"
BC18KC112	1/8" – 1/4"	75	1-1/2"	---	---	50	4.24"	1.06"	3.18"	1.50"	.63"
32M24TZ	1/8" – 1/4"	75	2"	---	---	50	5.51"	1.63"	3.88"	1.50"	.63"
6M58TZ	5/16" – 1/2"	75	---	3/8"	14-2 – 12-3	100	2.97"	1.29"	1.68"	1.50"	.63"
812M58TZ	5/16" – 1/2"	75	1/2" & 3/4"	---	---	100	3.34"	1.29"	2.05"	1.50"	.63"
BC516KC1	5/16" – 1/2"	75	1	---	---	50	3.58"	1.29"	2.52"	1.50"	.63"
BC516KC114	5/16" – 1/2"	75	1-1/4"	---	---	50	4.02"	1.29"	2.96"	1.50"	.63"
BC516KC112	5/16" – 1/2"	75	1-1/2"	---	---	50	4.47"	1.29"	3.18"	1.50"	.63"
BC516KC2	5/16" – 1/2"	75	2"	---	---	50	5.51"	1.63"	3.88"	1.50"	.63"
6M912TZ	9/16" – 3/4"	75	---	3/8"	14-2 – 12-3	100	3.31"	1.63"	1.68"	1.75"	.63"
812M912TZ	9/16" – 3/4"	75	1/2" & 3/4"	---	---	100	3.68"	1.63"	2.05"	1.75"	.63"
16M912TZ	9/16" – 3/4"	75	1"	---	---	50	4.15"	1.63"	2.52"	1.75"	.63"

SNAP-CLOSE CONDUIT TO FLANGE CLAMP

SIDE MOUNT



812M58SMTZ



24M58SMTZ

FEATURES

- Hammer-on installation
- Snap-close conduit clip pivots 360°
- Secures EMT, rigid and aluminum conduit to beams

APPLICATION

- Conduit flange mount snap-close clamps support EMT and rigid conduit from beams.
- Equipped with a rotatable joint allows the snap-close conduit clip to rotate 360° to position conduit in different directions

MATERIAL/FINISH

- Spring Steel/GEOSEAL™

CERTIFICATIONS

- UL Standard: UL 2239

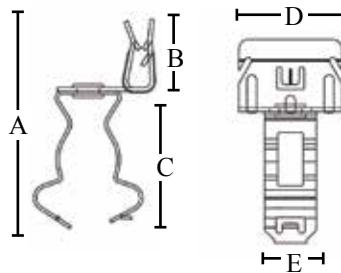

PART #	FLANGE THICKNESS	STATIC LOAD (LBS.)	EMT/RIGID SIZE	FMC SIZE	MC/AC SIZE	BOX QTY.	A	B	C	D	E
6M24SMTZ	1/8" – 1/4"	25	---	3/8"	14-2, 12-3	100	2.56"	.886"	1.68"	1.26"	.63"
16M24SMTZ	1/8" – 1/4"	25	1"	---	---	100	3.41"	.886"	2.52"	1.26"	.63"
20M24SMTZ	1/8" – 1/4"	25	1-1/4"	---	---	100	3.85"	.886"	2.96"	1.26"	.63"
24M24SMTZ	1/8" – 1/4"	25	1-1/2"	---	---	50	4.07"	.886"	3.18"	1.26"	.63"
32M24SMTZ	1/8" – 1/4"	25	2"	---	---	50	4.77"	.886"	3.88"	1.26"	.63"
812M24SMTZ	1/8" – 1/4"	25	1/2" & 3/4"	---	---	100	2.94"	.886"	2.05"	1.26"	.63"
16M58SMTZ	5/16" – 1/2"	25	1"	---	---	100	3.41"	.886"	2.52"	1.26"	.630
20M58SMTZ	5/16" – 1/2"	25	1-1/4"	---	---	100	3.83"	.866"	2.96"	1.26"	.63"
24M58SMTZ	5/16" – 1/2"	25	1-1/2"	---	---	50	4.07"	.886"	3.18"	1.26"	.63"
32M58SMTZ	5/16" – 1/2"	25	2"	---	---	50	4.77"	.886"	3.88"	1.26"	.63"
812M58SMTZ	5/16" – 1/2"	25	1/2" & 3/4"	---	---	100	2.92"	.866"	2.05"	1.26"	.63"
6M912SMTZ	9/16" – 3/4"	25	---	3/8"	14-2, 12-3	100	2.56"	.886"	1.68"	1.26"	.63"
16M912SMTZ	9/16" – 3/4"	25	1"	---	---	100	3.39"	.866"	2.52"	1.26"	.63"
20M912SMTZ	9/16" – 3/4"	25	1-1/4"	---	---	100	3.83"	.866"	2.96"	1.26"	.63"
32M912SMTZ	9/16" – 3/4"	25	2"	---	---	50	4.77"	.886"	3.88"	1.26"	.63"
812M912SMTZ	9/16" – 3/4"	25	1/2" & 3/4"	---	---	100	2.92"	.866"	2.05"	1.26"	.63"

HANGING AND SUPPORT

PUSH-CLOSE CONDUIT TO FLANGE CLIP

BOTTOM MOUNT



12P58TZ

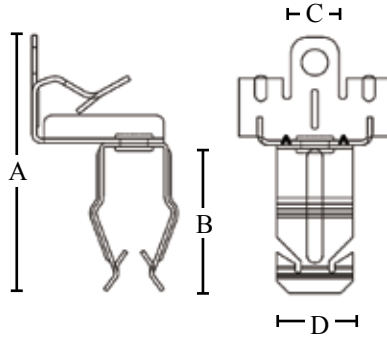

FEATURES

- Hammer-on installation
- Conduit clip pivots 360°
- Secures EMT, rigid and aluminum conduit to beams

APPLICATION

- Conduit flange mount clips support EMT and rigid conduit from beams.
- Equipped with a rotatable joint, the conduit clip rotates 360° to position conduit in different directions

MATERIAL/FINISH

- Spring Steel/GEOSEAL™

CERTIFICATIONS

- UL Standard: UL 2239



PART #	FLANGE THICKNESS	EMT SIZE	RIGID SIZE	STATIC LOAD (LBS.)	BOX QTY.	A	B	C	D
8P24TZ	1/8" – 1/4"	1/2"	---	25	100	2.52"	1.46"	1.50"	.748"
8P58TZ	5/16" – 1/2"	1/2"	---	25	100	2.75"	1.46"	1.50"	.748"
8P912TZ	9/16" – 3/4"	1/2"	---	25	50	3.09"	1.46"	1.50"	.748"
12P24TZ	1/8" – 1/4"	3/4"	1/2"	25	100	2.73"	1.67"	1.50"	.748"
12P58TZ	5/16" – 1/2"	3/4"	1/2"	25	100	2.96"	1.67"	1.50"	.748"
12P912TZ	9/16" – 3/4"	3/4"	1/2"	25	100	3.30"	1.67"	1.50"	.748"
16P24TZ	1/8" – 1/4"	1"	3/4"	25	100	3.01"	1.95"	1.50"	.748"
16P58TZ	5/16" – 1/2"	1"	3/4"	25	100	3.24"	1.95"	1.50"	.748"
16P912TZ	9/16" – 3/4"	1"	3/4"	25	100	3.58"	1.95"	1.50"	.748"

PUSH-CLOSE CONDUIT TO FLANGE CLIP

SIDE MOUNT



8P24SMTZ

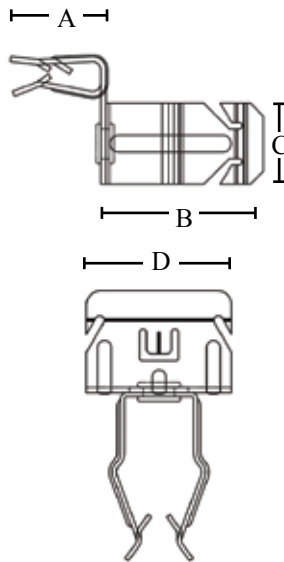

FEATURES

- Hammer-on installation
- Conduit clip pivots 360°
- Secures EMT, rigid and aluminum conduit to beams

APPLICATION

- Conduit flange mount clips support EMT and rigid conduit from beams.
- Equipped with a rotatable joint, the conduit clip rotates 360° to position conduit in different directions.

MATERIAL/FINISH

- Spring Steel/GEOSEAL™

CERTIFICATIONS

- UL Standard: UL 2239



PART #	FLANGE THICKNESS	EMT SIZE	RIGID SIZE	STATIC LOAD (LBS.)	BOX QTY.	A	B	C	D
8P24SMTZ	1/8" – 1/4"	1/2"	---	15	100	.886"	1.46"	.748"	1.26"
8P58SMTZ	5/16" – 1/2"	1/2"	---	15	100	.866"	1.46"	.748"	1.26"
8P912SMTZ	9/16" – 3/4"	1/2"	---	15	100	.866"	1.46"	.748"	1.26"
12P24SMTZ	1/8" – 1/4"	3/4"	1/2"	15	100	.886"	1.67"	.748"	1.26"
12P58SMTZ	5/16" – 1/2"	3/4"	1/2"	15	100	.866"	1.67"	.748"	1.26"
12P912SMTZ	9/16" – 3/4"	3/4"	1/2"	15	100	.866"	1.67"	.748"	1.26"
16P24SMTZ	1/8" – 1/4"	1"	3/4"	15	100	.886"	2.37"	.63"	1.26"
16P58SMTZ	5/16" – 1/2"	1"	3/4"	15	100	.866"	2.37"	.63"	1.26"
16P912SMTZ	9/16" – 3/4"	1"	3/4"	15	100	.866"	2.37"	.63"	1.26"

HANGING AND SUPPORT

CLAMPS & CLIPS



PUSH-IN CONDUIT CLIPS



12PTZ

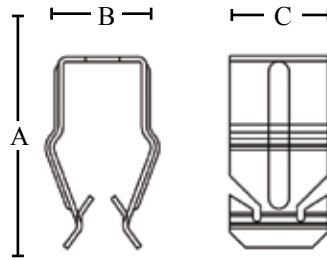

FEATURES

- Push-in attachment
- Vertical or horizontal mounting
- Combined with other Southwire fasteners to hang conduit to beams, purlins or rods

APPLICATION

- Conduit clips are mounted to structures to support EMT and rigid conduit
- Provides a convenient way to align conduit to electrical boxes

MATERIAL/FINISH

- Spring Steel/GEOSEAL™

CERTIFICATIONS

- UL Standard: UL 2239



PART #	EMT SIZE	RIGID SIZE	HOLE SIZE	HOLE TYPE	LOAD CAPACITY (LBS.)		A	B	C	BOX QTY.
					VERTICAL	HORIZONTAL				
8PTZ	1/2"	---	9/32"	PLAIN	25	15	1.46"	.67"	.748"	100
12PTZ	3/4"	1/2"	9/32"	PLAIN	25	15	1.67"	.709"	.748"	100
16PTZ	1"	3/4"	9/32"	PLAIN	25	15	2.37"	.787"	.63"	100

PUSH-IN CONDUIT HANGERS

BACK-TO-BACK FOR EMT



CHB-5075



FEATURES

- No tools are required for installation
- Simply snap in conduit and it is secured by sharp teeth that bite against the pipe's metallic surface

APPLICATION

- Back-to-back push-in conduit hangers allow the installer to support two conduit of the same or different sizes with the appropriate spacing required by code

MATERIAL/FINISH

- Spring Steel/Zinc plated

CERTIFICATIONS

- cULus listed

PART #	(1) EMT SIZE	(2) EMT SIZE	LOAD CAPACITY (LBS.)	BOX QTY.
8P8PTZ	1/2"	1/2"	25	100
CHB-5075	1/2"	3/4"	25	50
CHB-50100	1/2"	1"	25	50
CHB-75	3/4"	3/4"	25	50
CHB-75100	3/4"	1"	25	50
CHB-100	1"	1"	25	50

90° ANGLE BRACKET FOR EMT



CHPA-50

FEATURES

- Hanger provides a quick means of support for horizontal conduit runs of EMT, Rigid, MC/AC Cable through metal stud openings

APPLICATION

- Push-in conduit hangers are attached to an angle bracket that accommodates multiple mounting methods
- Hangers can be used with beam clamps or directly mounted to a variety of wood or metal surfaces when conduit need to be offset from walls

MATERIAL/FINISH

- Spring Steel/Zinc plated

PART #	EMT SIZE	BOX QTY.
CHPA-50	1/2"	50
CHPA-75	3/4"	50
CHPA-100	1"	50

SNAP-CLOSE CONDUIT CLAMPS



6MTZ

16MTZ

20MTZ

FEATURES

- Snap-close conduit attachment
- Vertical or horizontal mounting

APPLICATION

- Conduit clamps are mounted to structures to support EMT and rigid conduit
- Provides a convenient way to align conduit to electrical boxes

MATERIAL/FINISH

- Spring Steel/GEOSEAL™

CERTIFICATIONS

- UL Standard: UL 2239

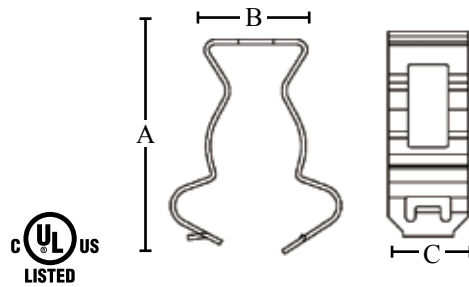

PART #	HOLE TYPE	HOLE SIZE	FMC SIZE	MC/AC SIZE	EMT RIGID SIZE	LOAD CAPACITY (LBS.)		BOX QTY.	A	B	C
						VERTICAL	HORIZONTAL				
6MTZ	PLAIN	9/32"	3/8"	14-2 - 12-3	---	100	25	100	1.68"	.807"	.63"
16MTZ	PLAIN	9/32"	---	---	1"	100	25	100	2.52"	.787"	.63"
20MTZ	PLAIN	9/32"	---	---	1-1/4"	100	25	100	2.96"	.807"	.63"
24MTZ	PLAIN	9/32"	---	---	1-1/2"	100	25	100	3.18"	.807"	.63"
32MTZ	PLAIN	9/32"	---	---	2"	100	25	100	3.88"	.807"	.63"
812MTZ	PLAIN	9/32"	---	---	1/2" & 3/4"	100	25	100	2.05"	.807"	.63"
6M4ITZ	THREADED	1/4"	3/8"	14-2 - 12-3	---	100	25	100	1.68"	.807"	.630
16M4ITZ	THREADED	1/4"	---	---	1"	100	25	100	2.52"	.787"	.63"
20M4ITZ	THREADED	1/4"	---	---	1-1/4"	100	25	100	2.96"	.807"	.63"
24M4ITZ	THREADED	1/4"	---	---	1-1/2"	100	25	100	3.18"	.807"	.63"
32M4ITZ	THREADED	1/4"	---	---	2"	100	25	100	3.88"	.807"	.63"
812M4ITZ	THREADED	1/4"	---	---	1/2" & 3/4"	100	25	100	2.05"	.807"	.63"

CONDUIT TO CONDUIT CLAMP



16812MTZ

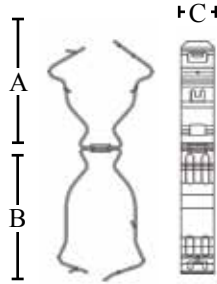

FEATURES

- Conduit quickly set in place and are secured by snapping the fastener closed to secure it in place
- Riveted assembly allows both conduit hangers to rotate to any position required

APPLICATION

- Snap-close conduit to conduit clamps support two conduit of different sizes running in parallel or perpendicular paths

MATERIAL/FINISH

- Spring Steel/GEOSEAL™

CERTIFICATIONS

- UL Standard: UL 2239

PART #	(1) EMT SIZE	(2) EMT SIZE	LOAD CAPACITY (LBS.)	BOX QTY.	A	B	C
16812MTZ	1/2" or 3/4"	1"	100	100	1.92"	2.39"	.629"
KCB-100100	1"	1"	100	50	2.29"	2.39"	.629"
KCB-100125	1"	1-1/4"	100	50	2.39"	2.96"	.629"

Total load must not exceed 100 lbs.

THROUGH STUD CABLE/CONDUIT CLAMP



BAKC38

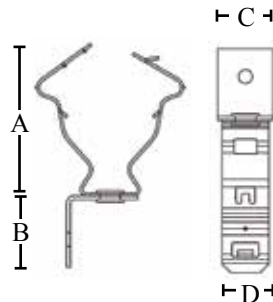

FEATURES

- Hanger provides a quick means of support for horizontal conduit runs of EMT, Rigid, MC/AC Cable through metal stud openings
- Supports 1/2", 3/4" EMT, 3/4" Rigid
- Reduces conduit rattling
- Screws to metal or wood studs

APPLICATION

- Snap-in conduit hangers are attached to an angle bracket that accommodates multiple mounting methods
- Hangers can be used with beam clamps or directly mounted to a variety of wood or metal surfaces when conduit need to be offset from walls

MATERIAL/FINISH

- Spring Steel/Black finish

CERTIFICATIONS

- UL or cULus

PART #	EMT SIZE	BOX QTY.	A	B	C	D
BAKC38*	3/8"	100	1.68"	.957"	.748"	.63"
FB812MTZ**	1/2" or 3/4"	100	2.05"	.957"	.748"	.63"

*UL | **cULus

CONDUIT HANGERS WITH BOLT



CD0BTZ

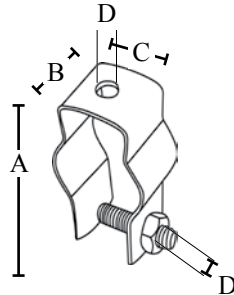

FEATURES

- Assembled with nut and bolt
- Use in areas where EMT or rigid conduit are used

APPLICATION

- Indoor or outdoor, use to secure and suspend conduit from overhead supports

MATERIAL/FINISH

- Steel/Zinc plated

CERTIFICATIONS

- UL Standard: UL2239



	RIGID SIZE	EMT SIZE	BOLT SIZE	BOX QTY.	A	B	C	D
CD0BTZ	1/2"	1/2"	1/4" – 20	100	1.875"	.75"	.725"	.25"
CD1BTZ	3/4"	3/4"	1/4" – 20	100	2.125"	.75"	.85"	.25"
CD2BTZ	1"	1"	1/4" – 20	100	2.437"	.875"	.975"	.25"
CD2.5BTZ	---	1-1/4"	1/4" – 20	100	2.875"	.875"	.975"	.25"
604	1-1/4"	1-1/2"	1/4" – 20	100	2.75"	.875"	.975"	.25"
CD4BTZ	1-1/2"	---	1/4" – 20	100	3.125"	1"	1.125"	.25"
CD5BTZ	2"	2"	1/4" – 20	50	3.875"	1"	1.145"	.25"
CD6BTZ	2-1/2"	2-1/2"	5/16" – 18	50	4.625"	1.25"	1.225"	.3125"
CD7BTZ	3"	3"	5/16" – 18	25	5.50"	1.25"	1.275"	.3125"
CD8BTZ	3-1/2"	3-1/2"	5/16" – 18	25	5.75"	1.25"	1.275"	.3125"
CD9BTZ	4"	4"	5/16" – 18	25	6.25"	1.25"	1.275"	.3125"

		PULL FORCE (LOAD RATING)					
		(EMT)		(RMC) (IMC)		RIGID PVC CONDUIT	
TRADE SIZE	METRIC DESIGNATOR	PULL FORCE (LBF)	REFERENCE LOAD RATING (LB)	PULL FORCE (LBF)	REFERENCE LOAD RATING (LB)	PULL FORCE (LBF)	REFERENCE LOAD RATING (LB)
1/2"	(16)	150	50	150	50	150	50
3/4"	(21)	150	50	150	50	150	50
1"	(27)	190	60	190	60	160	50
1-1/4"	(35)	225	75	225	75	175	55
1-1/2"	(41)	250	80	250	80	180	60
2"	(53)	300	100	300	100	200	65
2-1/2"	(63)	375	125	375 475	125 160	250	80
3"	(78)	500	160	500 875	165 295	300	100
3-1/2"	(91)	600	200	600 1125	200 375	375	125
4"	(103)	700	230	700	230	450	150

HANGING AND SUPPORT

CONDUIT HANGERS FOR EMT OR RIGID/IMC

SELF THREADING WITH BOLT (NO NUT)



SWO-WBA



FEATURES

- 3/8" - 2" self threading (no nut required)

APPLICATION

- Secures EMT or Rigid/IMC conduit to threaded rod, insulated supports, or mounting surface

MATERIAL/FINISH

- Steel/Zinc plated

CERTIFICATIONS

- cULus Listed

PART #	EMT SIZE	RIGID SIZE	BOX QTY.
SWO-WBA	1/2"	3/8"	100
1-WBA	3/4"	3/4"	100
2-WBA	1"	1"	100
2-1/2-WBA	1-1/4"	---	100
3-WBA	1-1/2"	1-1/4"	100
4-WBA	---	1-1/2"	100
5-WBA	2"	2"	50
6-WBA	2-1/2"	2-1/2"	50
7-WBA	3"	3"	50

CONDUIT HANGERS FOR EMT OR RIGID/IMC AND SWING BOLT



CHQ-50



SNAP ON CONDUIT,
SWING IN BOLT

FEATURES

- Swing in bolt feature saves installation time

APPLICATION

- For EMT only

MATERIAL/FINISH

- Steel/Zinc plated

PART #	EMT SIZE	BOX QTY.
CHQ-50	1/2"	50
CHQ-75	3/4"	25

CONDUIT HANGERS, WITH BOLT & NUT

STEEL



SW0-WBAS



CHSS-50

FEATURES

- Corrosion-resistant material is ideal for corrosive environments

APPLICATION

- Secures EMT or Rigid/IMC conduit to threaded rod, insulated supports, or mounting surface

MATERIAL/FINISH

- 301 and 316 Stainless steel

PART #	MATERIAL	EMT SIZE	RIGID SIZE	BOX QTY.	
CHSS-50	316 STAINLESS STEEL	1/2"	3/8" OR 1/2"	50	
CHSS-75		3/4"	3/4"	25	
CHSS-100		1"	1"	25	
CHSS-125		1-1/4"	---	25	
CHSS-150		1-1/2"	1-1/4"	25	
CHSS-175			1-1/2"	20	
CHSS-200		2"	2"	10	
CHSS-250		2-1/2"	2-1/2"	10	
CHSS-300		3"	3"	10	
CHSS-350		3-1/2"	3-1/2"	10	
CHSS-400		4"	4"	10	
SW0-WBAS		301 STAINLESS STEEL	1/2"	3/8"	100
1-WBAS			3/4"	3/4"	100
2-WBAS	1"		1"	100	
2-1/2-WBAS	1-1/4"		---	100	
3-WBAS	1-1/2"		1-1/4"	100	
4-WBAS			1-1/2"	100	
5-WBAS	2"		2"	50	
6-WBAS	2-1/2"		2-1/2"	50	
7-WBAS	3"		3"	25	
8-WBAS	3-1/2"		3-1/2"	25	
9-WBAS	4"	4"	25		

STRUT CLAMPS



STRUT CLAMP FOR EMT CONDUIT



SCE-50

FEATURES

- Hex/slotted nut, square bolt

APPLICATION

- Secures EMT electrical conduit perpendicular to strut.

MATERIAL/FINISH

- Steel/Electroplated zinc

PART #	EMT SIZE	INNER QTY.	MASTER QTY.
SCE-50	1/2"	---	100
SCE-75	3/4"	---	100
SCE-100	1"	---	100
SCE-125	1-1/4"	---	50
SCE-150	1-1/2"	---	50
SCE-200	2"	1	50

UNIVERSAL ONE-PIECE STRUT CLAMP



SK85ITZ



FEATURES

- For use with EMT/Rigid and IMC conduit
- All screws - 5/16" x 1-1/4" slotted hex head

APPLICATION

- Use to support stationary pipe and tubing lines from strut channel

MATERIAL/FINISH

- Steel/Zinc plated

CERTIFICATIONS

- UL Standard: UL 2239
- Fed. Spec: W-F-406E, W-F-406D
- NEMA: FB 1-2014

PART #	EMT RIGID SIZE	STATIC LOAD (LBS.)	BOX QTY.	A	B
SK85ITZ	1/2"	200	100	1.24"	2.30"
SK125ITZ	3/4"	200	100	1.24"	2.46"
SK165ITZ	1"	200	100	1.24"	2.68"
SK205ITZ	1-1/4"	200	100	1.24"	3.21"
SK245ITZ	1-1/2"	200	50	1.24"	3.42"
SK325ITZ	2"	200	50	1.24"	4"
SK405ITZ	2-1/2"	350	50	1.24"	5"
SK485ITZ	3"	350	25	1.24"	5.55"
SK565ITZ	3-1/2"	350	25	1.24"	6"
SK645ITZ	4"	350	25	1.24"	6.50"

HANGING AND SUPPORT

STRUT CLAMP - UNIVERSAL STEEL

STEEL



2101



FEATURES

- Hex/slotted nut, square bolt

APPLICATION

- Secures Rigid electrical conduit perpendicular to strut

CERTIFICATIONS

- cULus listed for 21XX series

PART #	EMT/RIGID SIZE	MATERIAL	BOX QTY.
2101	1/2"	ZINC PLATED STEEL	100
2102	3/4"		100
2103	1"		50
2104	1-1/4"		50
2105	1-1/2"		50
2106	2"		50
2107	2-1/2"		50
2108	3"		25
2109	3-1/2"		25
2110	4"		25
STR500	5"		25
STR600	6"		25

STRUT CLAMP - FOR RIGID CONDUIT

316 STAINLESS STEEL



STR50-SS



FEATURES

- Hex/slotted nut, square bolt

APPLICATION

- Secures Rigid electrical conduit perpendicular to strut

CERTIFICATIONS

- cULus listed for 21XX series

PART #	RIGID SIZE	MATERIAL	BOX QTY.
STR50-SS	1/2"	316 STAINLESS STEEL	100
STR75-SS	3/4"		100
STR100-SS	1"		100
STR125-SS	1-1/4"		100
STR150-SS	1-1/2"		100
STR200-SS	2"		100
STR250-SS	2-1/2"		100
STR300-SS	3"		100
STR350-SS	3-1/2"		100
STR400-SS	4"		100
STR500-SS	5"		25
STR600-SS	6"		25

STRUT CLAMP, ONE PIECE

SOFT SADDLE



OPCC-50



FEATURES

- Design has no screws or bolts to drop as you fit it to the strut channel
- Hex/slotted/phillips bolt

APPLICATION

- Secures electrical conduit or cable perpendicular to strut

MATERIAL/FINISH

- Steel/Galvanized

CERTIFICATIONS

- UL Listed

PART #	EMT/RIGID SIZE	BOX QTY.
OPCC-50	1/2"	100
OPCC-75	3/4"	100
OPCC-100	1"	50

BEAM CLAMP, REVERSIBLE STAMPED

STEEL OR 304 STAINLESS STEEL



JFCS-3816SS



FEATURES

- Through-hole in beam clamps allows drop rod length adjustment

APPLICATION

- Adjusts to accommodate the field installation finished height

MATERIAL/FINISH

- Steel/Zinc plated or 304 Stainless steel

CERTIFICATIONS

- UL Listed

PART #	MATERIAL	JAW OPENING	HOLE	BOX QTY.
JFCS-3816	ZINC PLATED STEEL	3/4"	3/8" – 16	25
JFCS-3816SS	304 STAINLESS STEEL	3/4"	3/8" – 16	25

ONE PIECE STRUT CLAMP



SCH12BTZ



SCH12TZ

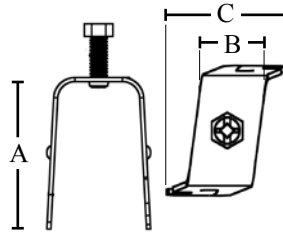

FEATURES

- Design has no screws or bolts to drop as you fit it to the strut channel
- Hex/slotted/Phillips bolt 1/4"-20 thread

APPLICATION

- Secures electrical conduit or cable perpendicular to strut

MATERIAL/FINISH

- Steel/Galvanized

CERTIFICATIONS

- UL Listed
- UL Standard: UL 2239

PART #	BOOT FEATURE	EMT SIZE	RIGID SIZE	STATIC LOAD	BOX QTY.	A	B	C
SCH8TZ	NO BOOT	1/2"	---	200	100	1.87"	.75"	1.34"
SCH12TZ	NO BOOT	3/4"	1/2"	200	100	2.13"	.75"	1.38"
SCH16TZ	NO BOOT	1"	3/4"	200	100	2.24"	.75"	1.38"
SCH20TZ	NO BOOT	1-1/4"	1"	200	100	2.48"	.75"	1.38"
SCH6BTZ	BOOT	3/8"	---	200	100	1.55"	.75"	1.22"
SCH8BTZ	BOOT	1/2"	---	200	100	1.87"	.75"	1.34"
SCH12BTZ	BOOT	3/4"	1/2"	200	100	2.13"	.75"	1.38"
SCH16BTZ	BOOT	1"	3/4"	200	100	2.24"	.75"	1.38"
SCH20BTZ	BOOT	1-1/4"	1"	200	100	2.48"	.75"	1.18"
SCH24BTZ	BOOT	1-1/2"	1-1/4"	350	50	2.78"	.75"	1.2"
SCH32BTZ	BOOT	2"	1-1/2"	350	50	3.29"	.75"	1.2"
SCH40BTZ	BOOT	---	2"	350	50	3.46"	.75"	.93"
SCH48BTZ	BOOT	2-1/2"	2-1/2"	350	24	4"	.75"	.83"
SCH56BTZ	BOOT	3"	3"	350	25	4.57"	.75"	.75"
SCH64BTZ	BOOT	3-1/2"	3-1/2"	350	10	5.12"	.75"	.75"
SCH72BTZ	BOOT	4"	4"	350	10	5.67"	.75"	.75"

ROD/WIRE HANGERS



CABLE/CONDUIT TO WIRE CLIP



PCS1TZ

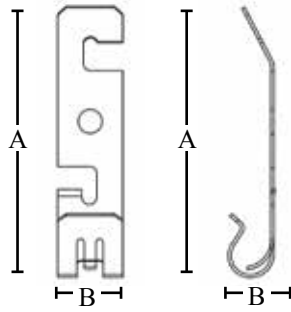

FEATURES

- Easy no-tool installation
- Attaches directly to drop wire with no additional bending

APPLICATION

- Provides support for cable and conduit from drop wire

MATERIAL/FINISH

- Spring Steel/GEOSEAL™

CERTIFICATIONS

- UL Standard: UL 2239



PART #	STATIC LOAD (LBS.)	EMT CONDUIT SIZE	MC/AC CABLE SIZE	WIRE SIZE	HOLE SIZE	BOX QTY.	A	B
PCS1TZ	25	---	14-2 – 10-3	#8 – #12	1/4"	100	3.11"	.748"
PCS2TZ	25	1/2" & 3/4"	10-3 – 6-3	#8 – #12	1/4"	100	3.52"	1"

CABLE/CONDUIT TO ROD/WIRE CLIP

PUSH-IN



4Z3412PTZ

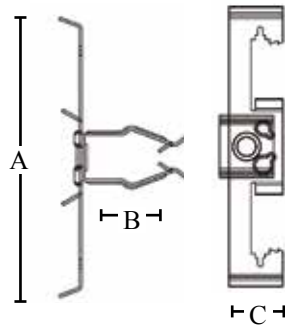

FEATURES

- Clip rotates 360° for conduit positioning
- Flange clip provides stability to the conduit clip
- Easy no-tool installation

APPLICATION

- Cable/conduit to rod/wire clips easily install to flanges or rods to support conduit, cables and boxes
- Equipped with a rotatable joint, the conduit clip rotates 360° to position conduit in different directions

MATERIAL/FINISH

- Spring Steel/GEOSEAL™

CERTIFICATIONS

- UL Standard: UL 2239



PART #	FLANGE THICKNESS	EMT SIZE	RIGID SIZE	ROD SIZE	WIRE SIZE	BOX QTY.	A	B	C
4Z348PTZ	1/8" – 3/8"	1/2"	---	1/4"	#12	100	3.87"	1.57"	.748"
4Z3412PTZ	1/8" – 3/8"	3/4"	1/2"	1/4"	#12	100	3.87"	1.67"	.748"
4Z3416PTZ	1/8" – 3/8"	1"	3/4"	1/4"	#12	100	3.87"	1.95"	.748"
6Z348PTZ	3/8" – 7/16"	1/2"	---	3/8"	---	100	3.62"	1.46"	.748"
6Z3412PTZ	3/8" – 7/16"	3/4"	1/2"	3/8"	---	100	3.62"	1.67"	.748"
6Z3416PTZ	3/8" – 7/16"	1"	3/4"	3/8"	---	100	3.62"	1.95"	.748"

CABLE/CONDUIT TO ROD/WIRE CLAMP

SNAP-CLOSE



4Z346MTZ

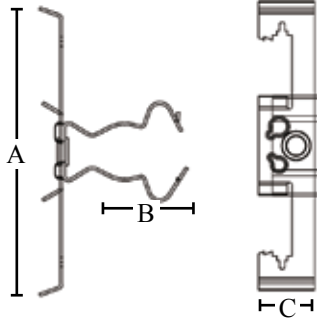

FEATURES

- Clip rotates 360° for conduit positioning
- Flange clip provides stability to the conduit clamp
- Easy no-tool installation

APPLICATION

- Cable/conduit to rod/wire clamps easily install to flanges or rods to support conduit, cables and boxes
- Equipped with a rotatable joint, the conduit clip rotates 360° to position conduit in different directions

MATERIAL/FINISH

- Spring Steel/GEOSEAL™

CERTIFICATIONS

- UL Standard: UL 2239



PART #	FLANGE THICKNESS	MC/AC CABLE SIZE	EMT SIZE	RIGID SIZE	ROD SIZE	WIRE SIZE	BOX QTY.	A	B	C
4Z346MTZ	1/8" – 3/8"	14-2 – 12-3	---	---	1/4"	#12	100	3.87"	1.68"	.748"
4Z3416MTZ	1/8" – 3/8"	---	1"	1"	1/4"	#12	100	3.87"	2.52"	.748"
4Z34812MTZ	1/8" – 3/8"	---	1/2" & 3/4"	1/2" & 3/4"	1/4"	---	100	3.87"	2.05"	.748"
6Z3416MTZ	3/8" – 7/16"	---	1"	1"	3/8"	#12	100	3.62"	2.52"	.748"
6Z34812MTZ	3/8" – 7/16"	---	1/2" & 3/4"	1/2" & 3/4"	3/8"	---	100	3.62"	2.05"	.748"

CABLE/CONDUIT TO ROD/WIRE CLIPS

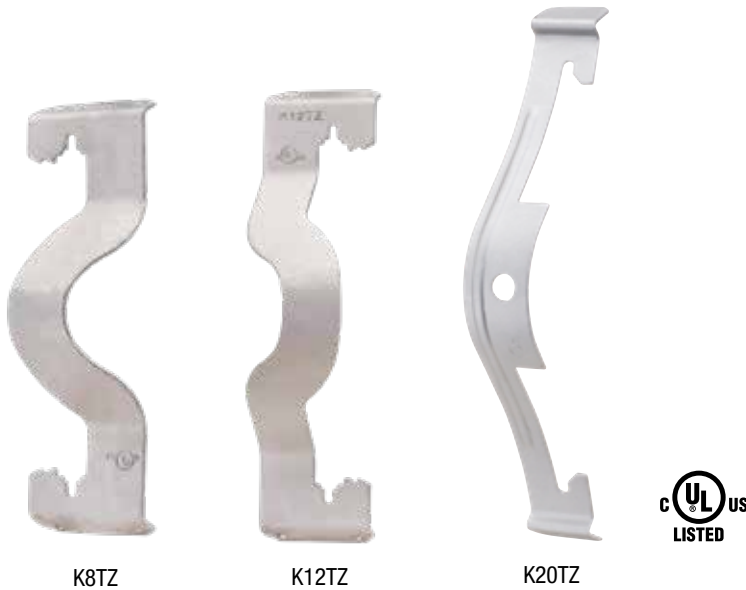

FEATURES

- Supports EMT, rigid, aluminum and NM conduit
- Spring Steel tightening feature keeps conduit and cables stable on rods or wire
- Easy no-tool installation

APPLICATION

- Cable/conduit to rod/wire no-tool installation clips are easily installed to flanges, rods, or wire to support conduit or cables.

MATERIAL/FINISH

- Spring Steel/GEOSEAL™

CERTIFICATIONS

- UL Standard: UL 2239

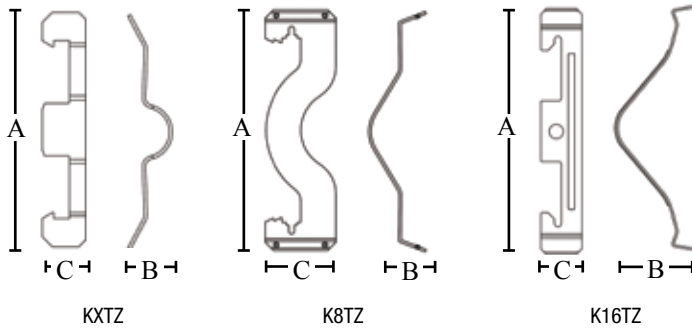

PART #	LOAD CAPACITY (LBS.)			A	B	C	BOX QTY.
	VERTICAL WIRE	HORIZONTAL FLANGE	VERTICAL FLANGE				
KXTZ	---	---	---	2.71"	.782	.504"	100
K8TZ	50	100	15	2.90"	.815	.626"	100
K12TZ	50	100	15	4"	.839"	1"	100
K16TZ	50	100	15	4.53"	1.50"	.756"	100
K20TZ	50	100	22	5.59"	1.78"	.756"	100

CONDUIT DATA

CONDUIT SIZE	#10, #12 WIRE	#8, #9 WIRE	3/16", 1/4" ROD	1/8" - 1/4" FLANGE	5/16" - 3/8" FLANGE	7/16" - 1/2" FLANGE
1/2" EMT	K8TZ	K8TZ	K8TZ	K8TZ	K12TZ	K12TZ
1/2" RIGID	K8TZ	K12TZ	K12TZ	K12TZ	K12TZ	K16TZ
3/4" EMT	K12TZ	K12TZ	K12TZ	K12TZ	K16TZ	K16TZ
3/4" RIGID	K12TZ	K12TZ	K16TZ	K16TZ	K20TZ	K20TZ
1" EMT	---	K16TZ	K16TZ	K16TZ	K20TZ	K20TZ
1" RIGID	---	---	---	K20TZ	K20TZ	K20TZ
1-1/4" EMT	---	K20TZ	K20TZ	K20TZ	---	---

CABLE DATA

CABLE SIZE	#12 WIRE	#8, #9, #10 WIRE
14-2, 14-3, 12-2	KXTZ	KXTZ
12-3	KXTZ	K8TZ

HANGING AND SUPPORT

CABLE HANGER



WMX6TZ

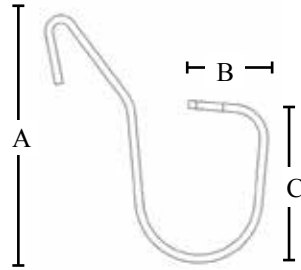

PART #	HOOK DIAMETER	STATIC LOAD (LBS.)	A	B	C	BOX QTY.
WMX3TZ	1-1/8"	50	2.94"	1.08"	2.14"	100
WMX6TZ	1-3/4"	75	4.52"	1.34"	3.34"	100

FEATURES

- Supports cables from beam, wire and flange clips

APPLICATION

- Provides convenient cable management for MC/AC and data cables when used with other Southwire spring steel fasteners

MATERIAL/FINISH

- Steel/Galvanized

CERTIFICATIONS

- UL Standard: UL 2239



COMBINATION BOX/ CONDUIT HANGERS



BOX/CONDUIT HANGER

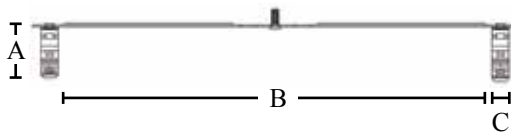

FEATURES

- Snap-close conduit clamps
- Center hole supports other Southwire fasteners attached to other structures

APPLICATION

- Conduit/box hangers are installed to drop wire, drop rod or other structures to support boxes in the center and conduit on either side

MATERIAL/FINISH

- Clamps: Spring steel
- Hangers: Galvanized steel
- GEOSEAL™

CERTIFICATIONS

- UL Standard: UL 2239



PART #	EMT SIZE	FMC SIZE	MC/AC CABLE SIZE	HOLE SIZE	HOLE TYPE
6MB18ATZ	---	3/8"	14-2 - 12-3	1/4"	PLAIN
16MB18ATZ	1"	---	---	1/4"	PLAIN
812MB18ATZ	1/2" & 3/4"	---	---	1/4"	PLAIN
812MB18STZ	1/2" & 3/4"	---	---	---	---

PART #	SCREW OPTION	SCREW LENGTH	THREAD SIZE	BOX QTY.	A	B	C
6MB18ATZ	NO	---	---	25	1.68"	18.11"	.63"
16MB18ATZ	NO	---	---	25	2.52"	18.11"	.63"
812MB18ATZ	NO	---	---	25	2.05"	18.11"	.63"
812MB18STZ	YES	9/16"	1/4" - 20	25	2.05"	18.11"	.63"

BOX/CONDUIT HANGER FROM ROD/WIRE



812MB18TZ

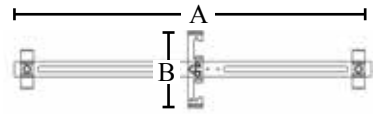

FEATURES

- Supports 1/2", 3/4" EMT
- Fits 1/4" Rod, #12 Wire

APPLICATION

- Supports conduit from wires or rods

MATERIAL/FINISH

- Spring Steel/GEOSEAL™

CERTIFICATIONS

- UL Standard: UL 2239

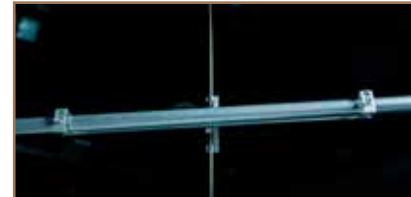

PART #	BOX QTY.	A	B	C
812MB18TZ	25	18.11"	3.87"	1.92"

ADJUSTABLE BAR HANGER



BHA1



FEATURES

- Box clip installs in 1/2" knockouts, located on the bottom of boxes
- Versatile design allows boxes to be installed anywhere along the length of the bar
- Not designed or intended for ceiling fan support
- Galvanized steel
- UL rated for 13 lbs. on 16" centers

APPLICATION

- Adjustable length box bar hangers can adjust from 16" through 24" and are designed for non-standard stud spacing
- These box supports are compatible with 1-1/2" and 2-1/8" deep boxes and are made of galvanized steel allowing for installation of electrical boxes anywhere along the length of the bar
- Box supports can accommodate 13 lbs. maximum load, can be used to install electrical boxes between ceiling joists or wall studs, and are suitable for fixtures or luminaires installation

MATERIAL/FINISH

- Steel/Galvanized

CERTIFICATIONS

- UL rated for 13 lbs. on 16" centers

PART #	JOIST OR STUD SPAN	BOX MOUNTING METHOD	MAX. RECOMMENDED STATIC FIXTURE SUPPORT (LBS.)	BOX QTY.
BHA1	16" TO 24"	BOX LOCK CLIP & THREADED STUD	13	50

PIPE FITTINGS



ONE HOLE RIGID STRAP



531

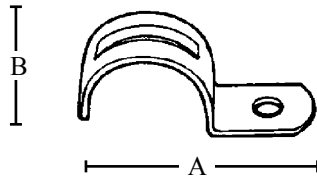

PART #	RIGID SIZE	BOX QTY.	A	B
531B	3/8"	100	1.81"	.562"
531	1/2"	50	1.91"	.625"
532	3/4"	50	2.21"	.75"
533	1"	25	2.57"	.875"
534	1-1/4"	20	2.79"	.88"
535	1-1/2"	20	3.69"	.899"
536	2"	10	4.17"	1.14"
517TZ*	2-1/2"	50	5"	1.28"
518TZ*	3"	25	5.55"	1.28"
519*	3-1/2"	25	6.37"	1.28"
520*	4"	25	6.87"	1.28"

*EMT and Rigid

FEATURES

- Snap-on Rigid strap with one hole
- Greater load bearing capability
- Easy to install

APPLICATION

- Indoor or outdoor, use to secure EMT, Rigid or IMC conduit to wood, masonry or wherever greater load bearing is required

MATERIAL/FINISH

- Steel/Zinc plated

CERTIFICATIONS

- UL Standard: UL 2239
- Fed. Spec: W-F-406E, W-F-406D
- NEMA: FB 1-2014



HANGING AND SUPPORT

ONE HOLE RIGID STRAP

316 STAINLESS STEEL



OHSSR-50



FEATURES

- Snap-on feature
- Inverted rib provides strength to keep cable secure
- 2-1/2" through 4" suitable for EMT conduit

APPLICATION

- Use to secure Rigid/IMC conduit in surface mount applications

MATERIAL/FINISH

- 316 Stainless steel

CERTIFICATIONS

- UL Listed (1/2" through 2")

PART #	RIGID SIZE	BOX QTY.
OHSSR-25	1/4"	100
OHSSR-38	3/8"	100
OHSSR-50	1/2"	100
OHSSR-75	3/4"	100
OHSSR-100	1"	50
OHSSR-125	1-1/4"	50
OHSSR-150	1-1/2"	25

HANGING AND SUPPORT

ONE HOLE EMT STRAP



511

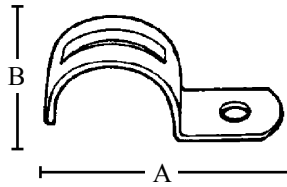

PART #	EMT SIZE	BOX QTY.	A	B
511	1/2"	100	1.79"	.57"
EPS0075EGTZ	3/4"	50	1.96"	.62"
EPS0100EGTZ	1"	25	2.25"	.75"
EPS0125EGTZ	1-1/4"	20	2.85"	.88"
EPS0150EGTZ	1-1/2"	20	3.16"	.99"
EPS0200EGTZ	2"	10	3.93"	1.10"
517TZ*	2-1/2"	50	5"	1.28"
518TZ*	3"	25	5.55"	1.28"
519*	3-1/2"	25	6.37"	1.28"
520*	4"	25	6.87"	1.28"

*EMT and Rigid

FEATURES

- Snap-on EMT strap with one hole
- Inverted rib for strength
- Easy no-tool installation

APPLICATION

- Indoor or outdoor, use to support EMT conduit to wood, masonry or where greater load bearing is required

MATERIAL/FINISH

- Steel/Zinc plated

CERTIFICATIONS

- UL Standard: UL 2239
- Fed. Spec: W-F-406E, W-F-406D
- NEMA: FB 1-2014



HANGING AND SUPPORT

ONE HOLE EMT STRAP

316 STAINLESS STEEL



OHSS-38

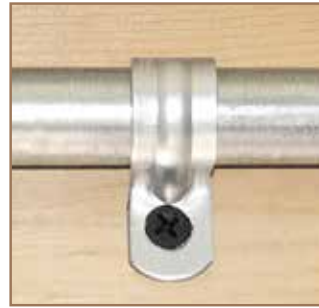

FEATURES

- Snap-on feature
- Inverted rib provides strength to keep cable secure

APPLICATION

- Use to secure EMT conduit in surface mount applications

MATERIAL/FINISH

- 316 Stainless steel

CERTIFICATIONS

- UL Listed (1/2" through 4")

PART #	EMT SIZE	BOX QTY.
OHSS-38	3/8"	100
OHSS-50	1/2"	50
OHSS-75	3/4"	50
OHSS-100	1"	25
OHSS-125	1-1/4"	25
OHSS-150	1-1/2"	25
OHSS-200	2"	25
OHSS-250	2-1/2"	10
OHSS-300	3"	10
OHSS-350	3-1/2"	10
OHSS-400	4"	10

ONE HOLE STRAP

FOR RIGID/IMC CONDUIT



OHSR-38M



FEATURES

- Heavy-duty casting

APPLICATION

- Use to secure Rigid/IMC conduit in surface mount applications

MATERIAL/FINISH

- Malleable iron/Zinc plated

CERTIFICATIONS

- cULus Listed

PART #	RIGID SIZE	INNER QTY.	MASTER QTY.
OHSR-38M	3/8"	---	50
561	1/2"	25	250
562	3/4"	25	250
563	1"	25	125
564	1-1/4"	20	100
565TZ	1-1/2"	10	100
566	2"	10	50
567	2-1/2"	5	25
568TZ	3"	---	5
569	3-1/2"	---	5
570	4"	---	5
570A	5"	---	2
570B	6"	---	2

ONE HOLE RIGID CLAMP BACK SPACER



481



FEATURES

- For use with malleable or aluminum straps

APPLICATION

- Use to provide space between conduit and mounting surface

MATERIAL/FINISH

- Malleable iron/Zinc plated

CERTIFICATIONS

- cULus Listed

PART #	RIGID SIZE	INNER QTY.	MASTER QTY.
481	1/2"	25	250
482	3/4"	25	250
483	1"	25	125
484	1-1/4"	20	100
485	1-1/2"	10	100
486	2"	10	50
487	2-1/2"	5	25
488	3"	N/A	10
489	3-1/2"	N/A	10
489A	4"	N/A	10
489B	5"	N/A	2
489C	6"	N/A	2

UNIVERSAL PVC CLAMP BACK SPACER



CLBU



FEATURES

- Stackable to elevate surface conduit
- Fits 1/2", 3/4", or 1" conduits
- Will not rust or corrode

APPLICATION

- Stackable to elevate surface conduit

MATERIAL/FINISH

- Zinc finish

PART #	SIZE	MASTER QTY.
CLBU	1/2" - 1"	50

HANGING AND SUPPORT

ONE HOLE SE/SEU STRAP



232A

PART #	WIRE SIZES	INNER QTY.	MASTER QTY.
232A	3 #3 OR #2	100	1000
282A	3 #1/0 OR #2/0	25	250
284A	3 #3/0 OR #4/0	20	100

FEATURES

- Wide wire range
- Stamped aluminum

APPLICATION

- Use to secure SE & SEU service entrance cable in surface mount applications

MATERIAL/FINISH

- Aluminum

ONE HOLE NM STRAP



510RX

PART #	WIRE SIZES	INNER QTY.	MASTER QTY.
510RX	14, 12, 10 IN 2 OR 3 CONDUCTOR, WITH OR WITHOUT GROUND. ALSO 14 IN UF	100	1000

FEATURES

- Inverted rib provides strength to keep cable secure

APPLICATION

- Use to secure Romex® Brand nonmetallic sheathed cable in surface mount applications

MATERIAL/FINISH

- Steel/Zinc plated

TWO HOLE SE/SEU STRAP



506

PART #	FOR WIRE SIZES	INNER QTY.	MASTER QTY.
501	3 #8, 6, 4	100	1000
502	3 #3, 2	100	1000
503	3 #1, 1/0, 2/0	25	250
504	3 #3/0, 4/0	25	250
506	3 #8 OR #6	100	500
507	3 # 4 OR #3	100	500
508	#1/0 OR #2/0	25	250
509	#4/0	20	100

FEATURES

- Inverted rib provides strength to keep cable secure
- Snap-on Rigid strap with two holes

APPLICATION

- Use to secure SE & SEU service entrance cable in surface mount applications

MATERIAL/FINISH

- Steel/Galvanized

TWO HOLE EMT STRAP

ZINC PLATED STEEL



THS-25

PART #	EMT SIZE	BOX QTY.
THS-25	1/4"	50
THS-38	3/8"	50
521TZ	1/2"	500
522	3/4"	500
523	1"	250
524	1-1/4"	50
525	1-1/2"	50
526	2"	50
527	2-1/2"	50
528TZ	3"	25
529TZ	3-1/2"	25
530TZ	4"	20

FEATURES

- Snap-on EMT strap with two holes
- Inverted rib provides strength to keep cable secure
- Easy to install

APPLICATION

- Use to secure EMT conduit in surface mount applications

MATERIAL/FINISH

- Steel/Zinc plated

316 STAINLESS STEEL



THSS-38



PART #	EMT SIZE	BOX QTY.
THSS-38	3/8"	50
THSS-50	1/2"	50
THSS-75	3/4"	50
THSS-100	1"	25
THSS-125	1-1/4"	25
THSS-150	1-1/2"	25
THSS-200	2"	25
THSS-250	2-1/2"	25
THSS-300	3"	10
THSS-350	3-1/2"	10
THSS-400	4"	10

FEATURES

- Snap-on EMT strap with two holes
- Inverted rib provides strength to keep cable secure
- Easy to install

APPLICATION

- Use to secure EMT conduit in surface mount applications

MATERIAL/FINISH

- Steel/316 Stainless steel

CERTIFICATIONS

- UL Listed

TWO HOLE RIGID STRAP



THSSR-50



FEATURES

- Inverted rib provides strength to keep cable secure
- Snap-on Rigid strap with two holes

APPLICATION

- Indoor or outdoor, use to secure EMT, Rigid or IMC conduit to wood, masonry or where greater load bearing is required

CERTIFICATIONS

- cULus Listed (except 123)
- UL Listed (for THSSR 1/2" THROUGH 2")

PART #	MATERIAL	RIGID SIZE	INNER QTY	BOX QTY.
123	ZINC PLATED STEEL	3/8"	100	500
541		1/2"	100	500
542		3/4"	50	250
543		1"	25	125
544	ZINC PLATED STEEL	1-1/4"	---	50
545		1-1/2"	---	50
546		2"	---	50
527		2-1/2"	---	50
528TZ		3"	---	25
529TZ		3-1/2"	---	25
530TZ		4"	---	20
530A		5"	---	10
530B		6"	---	10
THSSR-50		316 STAINLESS STEEL	1/2"	---
THSSR-75	3/4"		---	50
THSSR-100	1"		---	25
THSSR-125	1-1/4"		---	25
THSSR-150	1-1/2"		---	25
THSSR-200	2"		---	25
THSSR-250	2-1/2"		---	25
THSSR-300	3"		---	10
THSSR-350	3-1/2"		---	10
THSSR-400	4"		---	10

STRUCTURAL ATTACHMENTS

**Solutions to attach and support
electrical networks from building
structures**

BEAM/PURLIN

ROD/WIRE FASTENERS

FASTENERS/HARDWARE

BEAM/PURLIN



HAMMER-ON FLANGE CLIP



2H4TZ

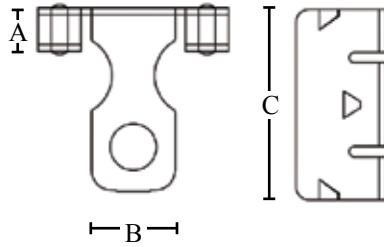

PART #	FLANGE SIZE	STATIC LOAD (LBS.)	BOX QTY.	A	B	C
2H4TZ	3/32" – 9/64"	160	100	.26"	.496"	1.13"
4H24TZ	1/8" – 1/4"	200	100	.37"	.512"	1.26"
4H58TZ	5/16" – 1/2"	200	100	.606"	.512"	1.26"
4H912TZ	9/16" – 3/4"	200	100	.866"	.512"	1.26"

FEATURES

- Hammer-on installation
- Provides 1/4" hanger hole
- Side mount

APPLICATION

- Provides an attachment solution to beam flanges for wire, hooks, and chains

MATERIAL/FINISH

- Spring Steel/GEOSEAL™

CERTIFICATIONS

- UL Standard: UL 2239



HANGING AND SUPPORT

FLANGE MOUNT THREADED ROD SUPPORT



4TI58TZ

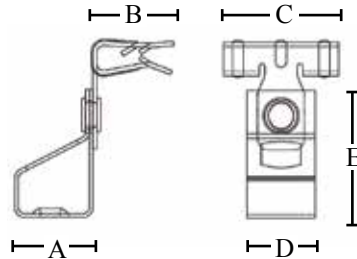

PART #	FLANGE THICKNESS	STATIC LOAD (LBS.)	BOX QTY.	A	B	C	D	E
4TI24TZ	1/8" – 1/4"	200	100	.85"	.866"	1.26"	.748"	1.48"
4TI58TZ	5/16" – 1/2"	200	100	.85"	.866"	1.26"	.748"	1.48"
4TI912TZ	9/16" – 3/4"	200	100	.85"	.866"	1.26"	.748"	1.48"

FEATURES

- Rotatable joint ensures rod maintains a vertical position
- Hammer-on installation

APPLICATION

- Supports 1/4" hole threaded rods from beams with flange clip

MATERIAL/FINISH

- Spring Steel/GEOSEAL™

CERTIFICATIONS

- UL Standard: UL 2239



DECK ROD HANGER



DH6TITZ

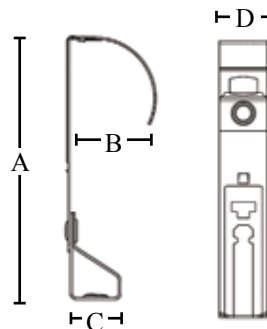

PART #	STATIC LOAD (LBS.)	BOX QTY.	A	B	C	D
DH6TITZ	160	100	4.90"	1.49"	.85"	.748"

FEATURES

- Supports 3/8" threaded rods

APPLICATION

- Attaches to deck tab to support threaded rods

MATERIAL/FINISH

- Spring Steel/GEOSEAL™

CERTIFICATIONS

- UL Standard: UL 2239



FLANGE MOUNT PLAIN ROD SUPPORT



6A24TZ

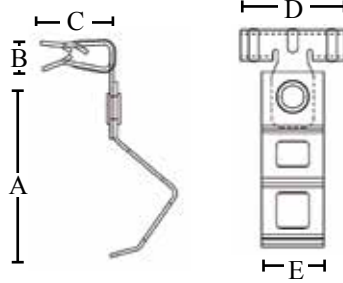

FEATURES

- Rotatable joint ensures rod maintains a vertical position
- Hammer-on installation
- Rod size 3/8"

APPLICATION

- Supports plain rods from beams with flange clip

MATERIAL/FINISH

- Spring Steel/GEOSEAL™

CERTIFICATIONS

- UL Standard 2239



PART #	FLANGE SIZE	STATIC LOAD (LBS.)	BOX QTY.	A	B	C	D	E
6A24TZ	1/8" – 1/4"	200	100	2.12"	.157"	.886"	1.26"	.748"
6A912TZ	9/16" – 3/4"	200	100	2.12"	.568"	.886"	1.26"	.748"

"Z" PURLIN ROD CLAMP



AF146TITZ

1224TITZ



FEATURES

- Designed to fit angle purlin flanges
- Rotatable joint ensures rod position maintains a vertical direction
- Hammer-on installation

APPLICATION

- Conforms to the angle of purlin to suspend plain or threaded rods

MATERIAL/FINISH

- Spring Steel/GEOSEAL™

CERTIFICATIONS

- UL Standard 2239

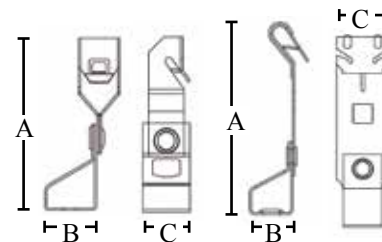

PART #	FLANGE SIZE	MOUNTING OPTION	ROD SIZE	HOLE TYPE	BOX QTY.	A	B	C
1224TITZ	3/32" MAX	SIDE	1/4"	THREADED	100	3.28"	.85"	.748"
1226TITZ	3/32" MAX	SIDE	3/8"	THREADED	100	3.28"	.85"	.748"
AF144TITZ	1/16" – 1/4"	FRONT	1/4"	THREADED	100	4.30"	.827"	1"
AF146TITZ	1/16" – 1/4"	FRONT	3/8"	PLAIN	100	4.30"	.827"	1"
AF146TITZ	1/16" – 1/4"	FRONT	3/8"	THREADED	100	4.30"	.827"	1"

HANGING AND SUPPORT

"Z" PURLIN CLIP



122TZ

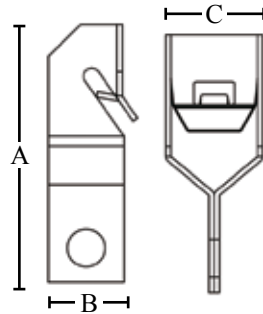

PART #	BOX QTY.	A	B	C
122TZ	100	1.88"	.551"	.709"

FEATURES

- 1/4" support hole
- Hammer-on installation
- Side mount
- 3/32" max flange thickness

APPLICATION

- Conforms to the angle of purlin to support wire, chains, and hooks.

MATERIAL/FINISH

- Spring Steel/GEOSEAL™

CERTIFICATIONS

- UL Standard 2239



ANGLED PURLIN STRAP HANGER



MSR122TZ



MSS122TZ



PART #	STRAP DIRECTION TO BEAM	STATIC LOAD (LBS.)	BOX QTY.	A	B	C	D
MSS122TZ	PARALLEL	100	50	2.49"	2.24"	.539"	.708"
MSR122TZ	RT. ANGLE	100	50	3.19"	2.24"	.709"	.709"

FEATURES

- Hammer-on installation
- 3/32" max flange thickness
- 1-1/4" max strap width

APPLICATION

- Conforms to the angle of purlin to support pipe, ducts, and other attachments with straps

MATERIAL/FINISH

- Spring Steel/GEOSEAL™
- Steel/Galvanized

CERTIFICATIONS

- UL Standard 2239

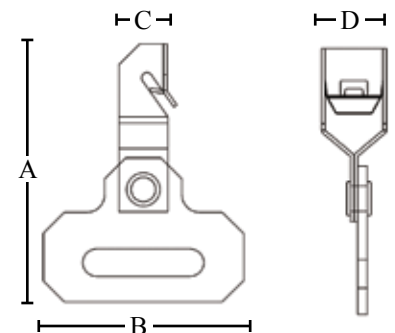

CONDUIT TO PURLIN CLAMP



123812MTZ

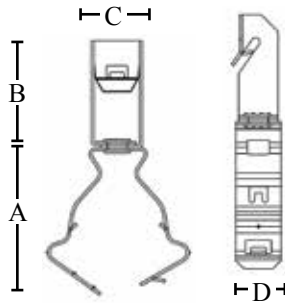

FEATURES

- Hammer-on installation
- Snap-close conduit clamp pivots 360° for easy positioning
- Supports 1/2" and 3/4" EMT
- 3/32" max flange

APPLICATION

- Supports EMT and Rigid conduit from angled purlins

MATERIAL/FINISH

- Spring Steel/GEOSEAL™

CERTIFICATIONS

- UL Standard 2239

PART #	BOX QTY.	A	B	C	D
123812MTZ	100	2.05"	1.49"	.709"	.630"

CONDUIT TO BEAM CLIPS

BOTTOM MOUNT



BC12PTZ

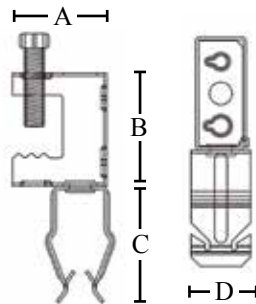

FEATURES

- Riveted conduit hanger rotates 360° to accommodate various directions of conduit
- Light-duty beam clamp provides a 25 lbs. static load capacity
- Additional 10 – 24 and 1/4" – 20 mounting holes on beam clamp

APPLICATION

- Push-in conduit hanger/beam clip assemblies are used when EMT or Rigid conduit must be supported below a structural beam

MATERIAL/FINISH

- Spring Steel/GEOSEAL™

CERTIFICATIONS

- UL Standard 2239

PART #	EMT SIZE	FLANGE SIZE	THREAD HOLE SIZE	LOAD CAPACITY (LBS.)
BC8PTZ	1/2"	1/2"	10 – 24 & 1/4" – 20	100
BC12PTZ	3/4"	1/2"	10 – 24 & 1/4" – 20	100
CHP-100-TM	1"	1/2"	10 – 24 & 1/4" – 20	100

PART #	BOX QTY.	A	B	C	D
BC8PTZ	100	1.18"	1.42"	1.46"	.748"
BC12PTZ	100	1.18"	1.42"	1.67"	.748"
CHP-100-TM	50	1.18"	1.42"	2.37"	.748"



HANGING AND SUPPORT

CONDUIT TO BEAM CLIPS

SIDE MOUNT



CHP-50-SM



FEATURES

- Riveted conduit hanger rotates 360° to accommodate various directions of conduit, perpendicular to beam edge
- Light-duty beam clamp provides a 25 lbs. static load capacity
- Additional 10-24 and 1/4"-20 mounting holes on beam clamp

APPLICATION

- Push-in conduit hanger/beam clip assemblies are used when EMT or Rigid conduit must be attached below a structural beam

MATERIAL/FINISH

- Spring Steel

PART #	EMT	FLANGE SIZE	BOX QTY.
CHP-50-SM	1/2"	1/2"	50
CHP-75-SM	3/4"	1/2"	50
CHP-100-SM	1"	1/2"	50

CONDUIT BEAM CLAMP

BOTTOM MOUNT



BC16MTZ

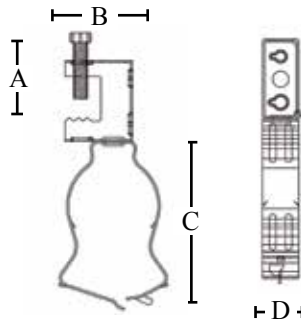

FEATURES

- Snap-close clip to secure conduit
- 1/2" max flange size

APPLICATION

- Snap-close conduit hanger/beam clamp assemblies are used when EMT or Rigid conduits must be supported below a structural beam

MATERIAL/FINISH

- Spring Steel/GEOSEAL™

CERTIFICATIONS

- UL Standard 2239

PART #	CONDUIT SIZE	STATIC LOAD (LBS.)	BOX QTY.	A	B	C	D
BC812MTZ	1/2" OR 3/4"	100	100	1.42"	1.18"	2.05"	.63"
BC16MTZ	1"	100	100	1.42"	1.18"	2.52"	.63"
BC20MTZ	1-1/4"	100	100	1.42"	1.18"	2.96"	.63"
BC24MTZ	1-1/2"	100	50	1.42"	1.18"	3.18"	.63"
BC32MTZ	2"	100	50	1.42"	1.18"	3.88"	.63"



CONDUIT BEAM CLAMP

SIDE MOUNT



BC16MSMTZ

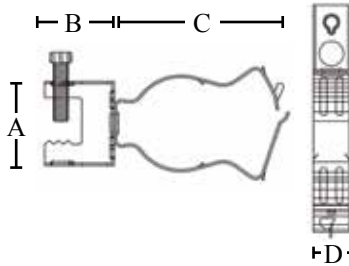

PART #	CONDUIT SIZE	STATIC LOAD (LBS.)	BOX QTY.	A	B	C	D
BC812MSMTZ	1/2" OR 3/4"	25	100	1.42"	1.18"	2.05"	.63"
BC16MSMTZ	1"	25	100	1.42"	1.18"	2.52"	.63"
BC20MSMTZ	1-1/4"	25	100	1.42"	1.18"	2.96"	.63"
BC24MSMTZ	1-1/2"	25	50	1.42"	1.18"	3.18"	.63"
BC32MSMTZ	2"	25	50	1.42"	1.18"	3.88"	.63"

FEATURES

- Snap-close clip to secure conduit
- 1/2" max flange size

APPLICATION

- Snap-close conduit hanger/beam clamp assemblies are used when EMT or Rigid conduits must be supported to a structural beam

MATERIAL/FINISH

- Spring Steel/GEOSEAL™

CERTIFICATIONS

- UL Standard 2239



FLANGE CLIP WITH STUD



M912STZ

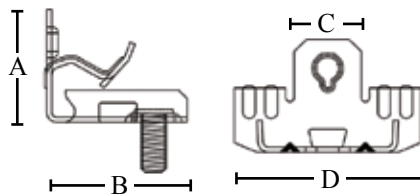

PART #	FLANGE THICKNESS	LOAD CAPACITY (LBS.)		
		VERTICAL ROD	HORIZONTAL ROD	VERTICAL STRAP
M24STZ	1/8" - 1/4"	100	25	75
M58STZ	5/16" - 1/2"	100	25	75
M912STZ	9/16" - 3/4"	100	25	75

PART #	BOX QTY.	A	B	C	D
M24STZ	100	1.06"	1.32"	.630"	1.75"
M58STZ	100	1.34"	1.36"	.630"	1.75"
M912STZ	100	1.63"	1.46"	.630"	1.75"

FEATURES

- Hammer-on installation
- 1/4"-20 Threaded stud; 3/8" length
- Accommodates 1/4" size rod
- Bottom mount

APPLICATION

- Attaches to beam flanges to support rods or straps
- Threaded stud feature provides support for outlet boxes

MATERIAL/FINISH

- Spring Steel/GEOSEAL™

CERTIFICATIONS

- UL Standard 2239



THREADED ROD FLANGE CLIP SUPPORT



M912TZ

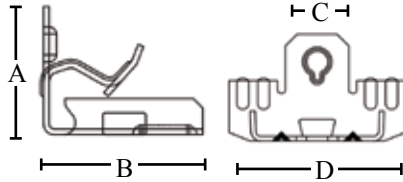

FEATURES

- Hammer-on installation
- Accommodates 1/4" rod size
- Bottom mount

APPLICATION

- Attaches to beam flanges to support rods, boxes, fixtures, or other necessary attachments

MATERIAL/FINISH

- Spring Steel/GEOSEAL™

CERTIFICATIONS

- UL Standard 2239

PART #	FLANGE THICKNESS	LOAD CAPACITY (LBS.)		
		VERTICAL ROD	HORIZONTAL ROD	VERTICAL STRAP
M24TZ	1/8" – 1/4"	100	25	75
M58TZ	5/16" – 1/2"	100	25	75
M912TZ	9/16" – 3/4"	100	25	75

PART #	BOX QTY.	A	B	C	D
M24TZ	100	1.06"	1.32"	.63"	1.75"
M58TZ	100	1.34"	1.36"	.63"	1.75"
M912TZ	100	1.63"	1.46"	.63"	1.75"



STRAP HANGER FLANGE CLIP



MSS912TZ

MSR58TZ



PART #	FLANGE SIZE	STRAP DIRECTION TO BEAM	STATIC LOAD (LBS.)
MSS24TZ	1/8" – 1/4"	PARALLEL	200
MSS58TZ	5/16" – 1/2"	PARALLEL	200
MSS912TZ	9/16" – 3/4"	PARALLEL	200
MSR58TZ	5/16" – 1/2"	RIGHT ANGLE	200

PART #	BOX QTY.	A	B	C	D
MSS24TZ	50	2.19"	.886"	1.60"	2.24"
MSS58TZ	50	2.46"	.886"	1.60"	2.24"
MSS912TZ	50	2.70"	.886"	1.60"	2.24"
MSR58TZ	50	2.77"	.866"	1.26"	2.24"

FEATURES

- Hammer-on installation
- Strap width 1-1/4" max

APPLICATION

- Attaches to beam flange to support pipes, ducts, or other attachments with straps.

MATERIAL/FINISH

- Spring Steel/GEOSEAL™

CERTIFICATIONS

- UL Standard 2239

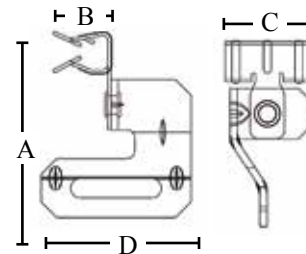
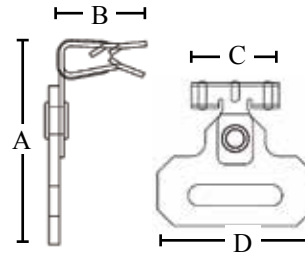

VERTICAL ANGLED FLANGE HANGER



VF14TZ



PART #	BOX QTY.	A	B	C
VF14TZ	100	2.94"	1"	.354"

FEATURES

- Fits purlin and bar joists with 1/16" to 1/4" flange
- 1/4" Hole size

APPLICATION

- Use to support wire, chains, and S-hooks from vertical purlins
- Hammer-on installation

MATERIAL/FINISH

- Spring Steel/GEOSEAL™

CERTIFICATIONS

- UL Standard 2239

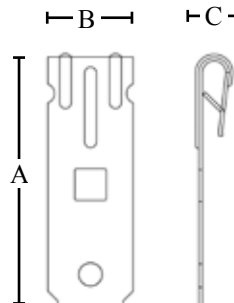

ANGLE FLANGE HANGER



AF14TZ



PART #	STATIC LOAD (LBS.)	BOX QTY.	A	B	C	D
AF14TZ	100	100	2.91"	1"	.701"	.486"

FEATURES

- Supports flanges from 1/16" to 1/4"
- 1/4" support hole
- Hammer-on installation

APPLICATION

- Designed to hang from angle purlin to provide support for wires, chains, and hooks

MATERIAL/FINISH

- Spring Steel/GEOSEAL™

CERTIFICATIONS

- UL Standard 2239

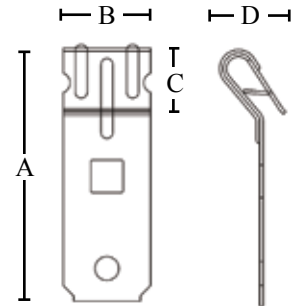

6-1/4" WIDE MOUTH BEAM CLAMP

LIGHT-DUTY



BC-1420-XWM



FEATURES

- 1/4"-20 thread impressions
- Stamped steel

APPLICATION

- Light duty beam clamp supports loads from structural beams

MATERIAL/FINISH

- Steel

PART #	JAW	HOLE THREAD	BOX QTY.
BC-1420-XWM	6-1/4"	1/4"-20	20

CONDUIT HANGER WITH STEEL BEAM CLAMP ASSEMBLY



CHBC-50



FEATURES

- Riveted conduit hanger rotates 360° to accommodate various directions of conduit
- Stamped steel construction and hardened set screw provides a 100 lbs. static load capacity
- Additional 1/4" – 20 mounting hole on back of beam clamp

APPLICATION

- Conduit hanger/beam clamp assemblies are used when EMT or Rigid conduit must be supported below a structural beam

MATERIAL/FINISH

- Zinc plated

PART #	FOR EMT SIZE	FOR RIGID SIZE	BOX QTY.
CHBC-50	1/2"	1/2"	50
CHBC-75	3/4"	3/4"	50
CHBC-100	1"	1"	50
CHBC-125	1-1/4"	---	50
CHBC-150	1-1/2"	1-1/4"	50
CHBC-175	---	1-1/2"	50
CHBC-200	2"	2"	50

BEAM CLAMP

316 STAINLESS STEEL



MBC-3816-SS

FEATURES

- Tapped holes on side and bottom

APPLICATION

- Stainless steel beam clamps are used to support conduit hangers, bridle rings and drop rods in harsh environments where corrosion is an issue

MATERIAL/FINISH

- Body and Set Screw: Steel/316 Stainless

PART #	FLANGE THICKNESS	SIDE/BOTTOM THREADED HOLES	STATIC LOAD (LBS)	BOX QTY.
MBC-1420-SS	3/8"	1/4" – 20	250	50
MBC-3816-SS	3/8"	3/8" – 16	500	25

BEAM CLAMPS



BC-1024

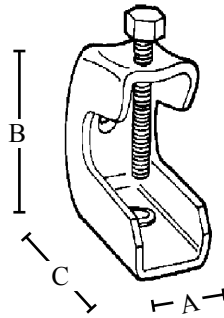

PART #	MATERIAL	ROD SIZE	JAW OPENING	BOX QTY.	A	B	C
BC-1024*	ZINC PLATED STEEL	10 - 24	.59"	100	.92"	1.40"	1.63"
BC200TZ**		1/4" - 20	.59"	100	.92"	1.40"	1.63"
BC400TZ**		3/8" - 16	.94"	50	1.21"	2.062"	2.25"
BC-1420-SS*	316 STAINLESS STEEL	1/4" - 20	.59"	100	.92"	1.40"	1.63"
BC-3816-SS*		3/8" - 16	.94"	25	1.21"	2.062"	2.25"

* UL listed | ** cULus listed

FEATURES

- Side and bottom tapped holes

APPLICATION

- Light duty beam clamp supports loads from structural beams

CERTIFICATIONS

- UL listed or cULus Listed



HANGING AND SUPPORT

STEEL



BCTZ

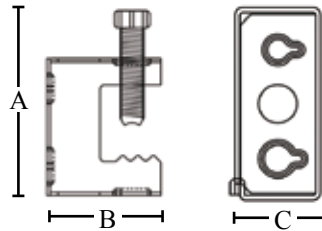

PART #	STATIC LOAD (LBS.)	BOX QTY.	A	B	C
BCTZ	100	100	1.42"	1.18"	.63"

FEATURES

- Supports flanges up to 1/2"
- Holes in the back and bottom supports #10-24 and 1/4"-20 threaded bridle rings

APPLICATION

- Clamps to flanges to support a variety of attachments from beams.

MATERIAL/FINISH

- Steel/GEOSEAL™

CERTIFICATIONS

- UL Standard: UL 2239



BEAM CLAMPS

MALLEABLE IRON



26



PART #	SIZE	JAW OPENING	SIDE/BOTTOM THREADED HOLES	STATIC LOAD (LBS.)	BOX QTY.
26	1"	3/4"	1/4"-20	450	50
27	2"	7/8"	3/8"-16	1300	10
29	2-1/2"	1-3/16"	1/2"-13	1700	10

FEATURES

- Tapped holes on side and bottom

APPLICATION

- Malleable iron beam clamps are used to support conduit hangers, bridle rings and drop rods

MATERIAL/FINISH

- Malleable iron/Zinc plated

CERTIFICATIONS

- UL Listed, CSA Listed

SLIM-BODY - MALLEABLE IRON



MBC-3816EV



PART #	JAW OPENING	ROD SIZE	STATIC LOAD (LBS.)	BOX QTY.
MBC-3816EV*	3/4"	3/8"	900	50
122**	3/4"	1/4" - 20	125	50
123A**	3/4"	3/8" - 16	300	50
123TZ**	7/8"	3/8" - 16	300	50
MBC-1420	7/8"	1/4" - 20	450	50
MBC-3816	1 1/8"	3/8" - 16	1300	25
124TZ**	1-1/8"	1/2" - 13	600	25
MBC-1213	1 3/8"	1/2" - 13	1700	10

* UL listed | ** No UL

FEATURES

- Tapped holes on side and bottom

APPLICATION

- Malleable iron beam clamps are used to support conduit hangers, bridle rings and drop rods

MATERIAL/FINISH

- Malleable iron/Zinc plated

CERTIFICATIONS

- UL Listed*

HANGING AND SUPPORT

BEAM CLAMPS

WIDE MOUTH



MBC-1420WM



FEATURES

- Tapped holes on side and bottom

APPLICATION

- Wide-mouth malleable iron beam clamps are used with large flange beams to support conduit hangers, bridle rings and drop rods

MATERIAL/FINISH

- Iron/Zinc plated

CERTIFICATIONS

- UL Listed

PART #	JAW OPENING	SIDE/BOTTOM THREADED HOLES	STATIC LOAD (LBS.)	BOX QTY.
MBC-1420WM	3-1/8"	1/4"-20	200	50
MBC-3816WM	3-1/8"	3/8"-16	300	25
MBC-1213WM	3-1/8"	1/2"-13	400	10

HEAVY-DUTY BODY, MALLEABLE IRON



MBC-1024



FEATURES

- Tapped holes on side and bottom

APPLICATION

- Malleable iron beam clamps are used to support conduit hangers, bridle rings and drop rods

MATERIAL/FINISH

- Malleable iron/Zinc plated

CERTIFICATIONS

- UL Listed

PART #	JAW OPENING	HOLE THREAD	STATIC LOAD (LBS.)	BOX QTY.
MBC-1213XL	31/32"	1/2"-13	1700	50
MBC-1024	7/8"	10"-24	250	100

UNIVERSAL BEAM CLAMP



3000037EGTZ

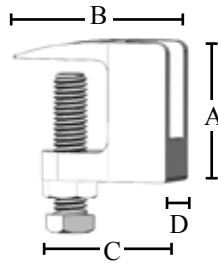

FEATURES

- Electrogalvanized coating for corrosion protection
- Threaded rod attaches vertically from back of clamp

APPLICATION

- Provides a connection point for threaded rods or bridle rings from beam flange

MATERIAL/FINISH

- Malleable iron

CERTIFICATIONS

- UL Standard: UL 2239



PART #	FLANGE THICKNESS	ROD SIZE	MOUNT LOAD (LBS.)	BOX QTY.	A	B	C	D
3000037EGTZ	3/4"	3/8"	300	100	1.60"	1.88"	1.79"	.792
3000050EGTZ	3/4"	1/2"	300	100	1.64"	1.70"	1.78"	1.04
3000062EGTZ	3/4"	5/8"	300	50	1.85"	1.84"	1.82"	1.18
3000075EGTZ	3/4"	3/4"	300	50	1.87"	2.29"	2.12"	1.31
3100037EGTZ	1-1/4"	3/8"	300	50	2.03"	1.67"	2.31"	.948
3100050EGTZ	1-1/4"	1/2"	300	50	2.10"	1.67"	2.33"	1.02

BEAM CLAMP, REVERSIBLE

MALLEABLE IRON



3000037PLTZ



FEATURES

- Through-hole in beam clamps allows drop rod length adjustment
- Hardened cup point set screws come with jam nuts to prevent vibratory loosening in industrial settings

APPLICATION

- Reversible beam clamps are used when drop rod length needs to be adjusted to accommodate the field installation finished height

MATERIAL/FINISH

- Malleable iron/Unfinished (black)

CERTIFICATIONS

- UL Listed or cULus listed



PART #	JAW OPENING	ROD SIZE	STATIC LOAD (LBS.)		BOX QTY.
			TOP MOUNT	BOTTOM MOUNT	
3000037PLTZ**	3/4"	3/8"	300	---	100
MFC-3816	1-1/4"	3/8" - 16	500	250	25
MFC-1213	1-1/4"	1/2" - 13	500	250	25
MFC-5811*	1-3/8"	5/8" - 11	750	400	25
MFC-3410*	1-3/8"	3/4" - 10	1000	600	25

* UL listed | ** cULus listed

HANGING AND SUPPORT

LIGHT DUTY BEAM CLAMP, REVERSIBLE

MALLEABLE IRON



JFC-1420



FEATURES

- Through-hole in beam clamps allows drop rod length adjustment
- Hardened cup point set screws come with jam nuts to prevent vibratory loosening in industrial settings

APPLICATION

- Reversible beam clamps are used when drop rod length needs to be adjusted to accommodate the field installation finished height

MATERIAL/FINISH

- Malleable iron/Zinc plated

CERTIFICATIONS

- UL Listed

PART #	JAW OPENING	HOLE THREAD	STATIC LOAD (LBS.)		BOX QTY.
			TOP MOUNT	BOTTOM MOUNT	
JFC-1420	3/4"	1/4 - 20	250	100	50
JFC-3816	3/4"	3/8 - 16	500	250	25
JFC-1213	3/4"	1/2 - 13	500	250	25
JFC-5811	7/8"	5/8 - 11	750	400	25

BEAM CLAMP/ROD-HANGER



126Z

FEATURES

- Formed steel construction

APPLICATION

- C-style rod hanger clamps are used as structural attachments to metal beams, purlins, channels and angle irons to support boxes, enclosures and fixtures from threaded rods

MATERIAL/FINISH

- Steel/Electroplated zinc or 304 Stainless steel

PART #	MATERIAL	JAW OPENING	BOTTOM MOUNTING HOLE THREAD	BOX QTY.
126TZ	ZINC PLATED STEEL	3/4"	3/8 - 16	25
SCC-1213		3/4"	1/2 - 13	25
SCC-5811		3/4"	5/8 - 11	25
SCC-3410		3/4"	3/4 - 10	25
SCC-3816SS	304 STAINLESS STEEL	3/4"	3/8 - 16	25
SCC-1213SS		3/4"	1/2 - 13	25
SCC-5811SS		3/4"	5/8 - 11	25
SCC-3410SS		3/4"	3/4 - 10	25
SCC-3816BK	UNFINISHED (BLACK) STEEL	3/4"	3/8 - 16	25
SCC-1213BK		3/4"	1/2 - 13	25
SCC-5811BK		3/4"	5/8 - 11	25
SCC-3410BK		3/4"	3/4 - 10	25



BEAM CLAMP/ROD-HANGER

MALLEABLE IRON



MCC-3816

FEATURES

- For vertical loads

APPLICATION

- C-style rod hanger clamps are used as structural attachments to metal beams, purlins, channels and angle irons to support boxes, enclosures and fixtures from threaded rods

MATERIAL/FINISH

- Malleable iron/Zinc plated or unfinished

PART #	MATERIAL	JAW OPENING	HOLE THREAD	BOX QTY.
MCC-3816	ZINC PLATED IRON	3/4"	3/8 – 16	25
MCC-1213		3/4"	1/2 – 13	25
MCC-5811		3/4"	5/8 – 11	25
MCC-3410		3/4"	3/4 – 10	25
MCC-3816BK	UNFINISHED (BLACK) IRON	3/4"	3/8 – 16	25
MCC-1213BK		3/4"	1/2 – 13	25
MCC-5811BK		3/4"	5/8 – 11	25
MCC-3410BK		3/4"	3/4 – 10	25



BEAM CLAMP

PARALLEL EDGE



1561HDG

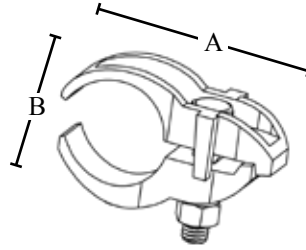

PART #	SIZE	BOX QTY.	A	B
1561HDG	1/2"	50	2.80"	1.42"
1562HDG	3/4"	50	2.99"	1.47"
1563HDG	1"	50	3.19"	1.54"
1564HDG	1-1/4"	25	3.39"	2.01"
1565HDG	1-1/2"	25	3.62"	2.01"
1566HDG	2"	25	4.37"	2.87"
1567HDG	2-1/2"	10	5.12"	3.23"
1568HDG	3"	10	5.79"	4.06"
1569HDG	3-1/2"	10	6.26"	4.53"
1570HDG	4"	10	6.46"	4.61"

FEATURES

- Hot dip galvanized over malleable iron for added durability and corrosion protection

APPLICATION

- Parallel beam conduit clamps are used to mount EMT, rigid, or IMC conduit parallel to beam, channel and angle supports

MATERIAL/FINISH

- Malleable iron/Hot dip galvanized

CERTIFICATIONS

- UL Listed: UL Standard 2239

CROSS BEAM EDGE



1571HDG

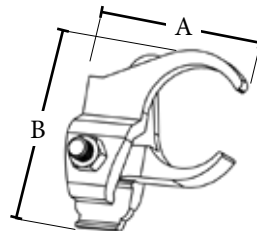

PART #	SIZE	BOX QTY.	A	B
1571HDG	1/2"	50	2.10"	2.72"
1572HDG	3/4"	50	2.44"	3.01"
1573HDG	1"	50	2.57"	3.23"
1574HDG	1-1/4"	25	2.96"	3.47"
1575HDG	1-1/2"	25	3.27"	3.65"
1576HDG	2"	25	3.85"	4.36"
1577HDG	2-1/2"	10	4.40"	5.05"
1578HDG	3"	10	5.08"	5.41"

FEATURES

- Malleable iron construction

APPLICATION

- Beam edge conduit clamps are used to mount EMT or rigid conduit perpendicular to beam, channel and angle supports

MATERIAL/FINISH

- Malleable iron/Hot dip galvanized

BEAM CLAMP

J-STYLE UNDER BEAM



JCL50

PART #	SIZE	BOX QTY.
JCL50	1/2"	50
JCL75	3/4"	50
JCL100	1"	25
JCL125	1-1/4"	25
JCL150	1-1/2"	25
JCL250	2-1/2"	5
JCL350	3-1/2"	1

FEATURES

- Zinc plated malleable iron construction provides a secure and durable connection

APPLICATION

- J-style conduit beam clamps are used with metallic and flexible conduit
- Clamp allows conduit to be clamped to the parallel or perpendicular 90° to the beam

MATERIAL/FINISH

- Malleable iron/Zinc plated



RIGHT ANGLE UNDER BEAM - MALLEABLE IRON



1551HDG

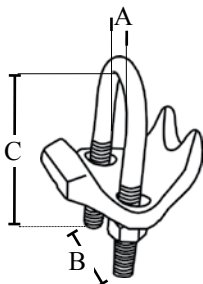

FEATURES

- Hot dip galvanized over malleable iron for added durability and corrosion protection

APPLICATION

- Right angle conduit clamps are used to mount EMT or rigid conduit across, parallel, or perpendicular to beam, channel or angle supports

MATERIAL/FINISH

- Malleable iron/Hot dip galvanized

CERTIFICATIONS

- UL Listed

PART #	SIZE	BOX QTY.	A	B	C
1551HDG	1/2"	50	.97"	1.24"	2.46"
1552HDG	3/4"	50	1.15"	1.43"	2.76"
1553HDG	1"	50	1.42"	1.70"	3.01"
1554HDG	1-1/4"	50	1.79"	2.07"	3.16"
1555HDG	1-1/2"	50	2.04"	2.32"	3.52"
1556HDG	2"	50	2.49"	2.83"	4.39"
1557HDG	2-1/2"	25	3.06"	3.39"	4.75"
1558HDG	3"	25	3.65"	3.98"	5.38"
1559HDG	3-1/2"	25	4.21"	4.55"	5.76"
1559AHDG	4"	25	4.69"	5.03"	6.27"

ROD/WIRE FASTENERS

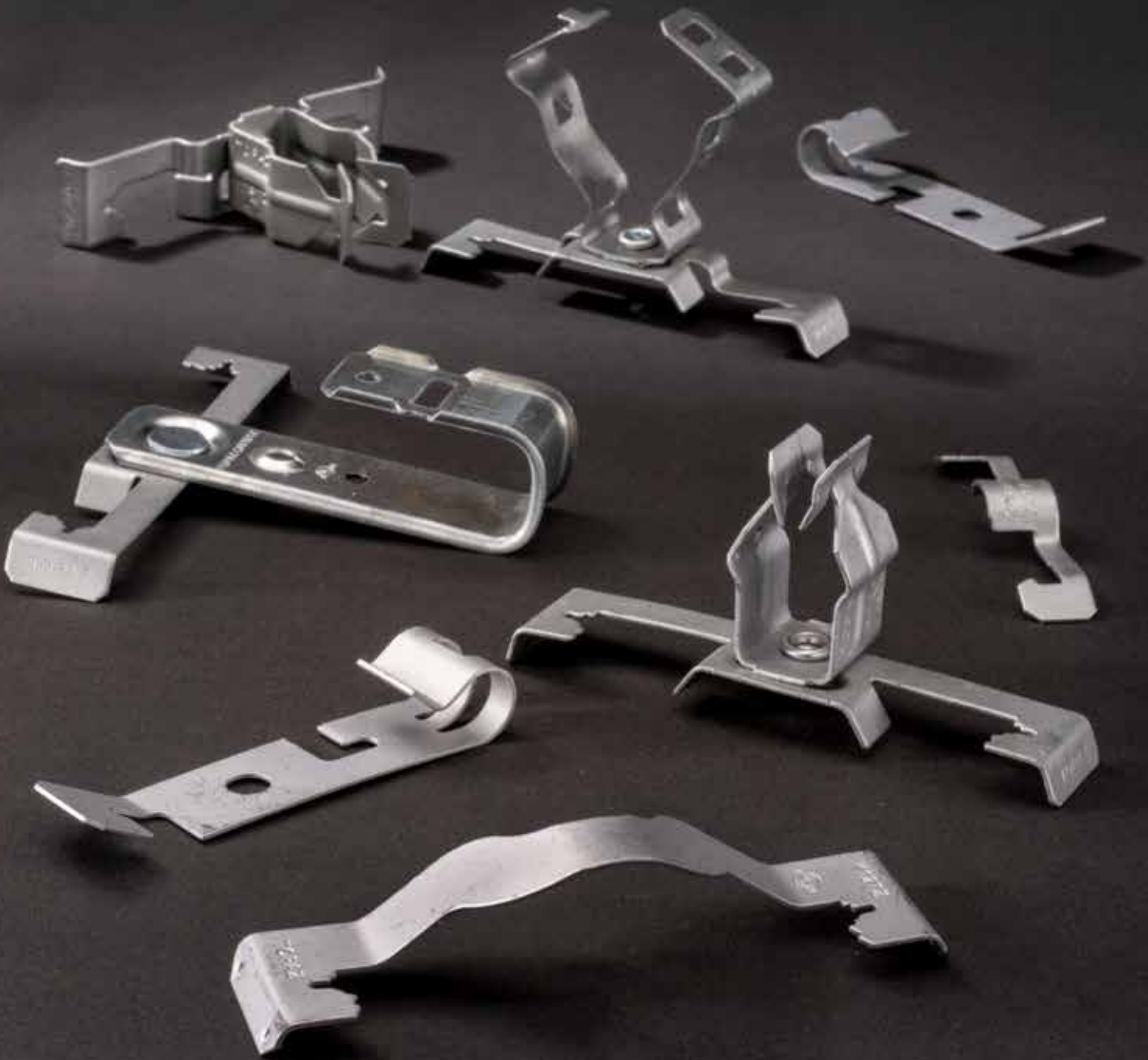

THREADED ANGLE ROD BRACKET



6TIBTZ

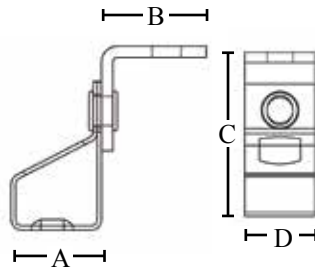

PART #	THREAD SIZE	STATIC LOAD (LBS.)	BOX QTY.	A	B	C	D
4TIBTZ	1/4"	160	100	.85"	.984"	1.70"	.748"
6TIBTZ	3/8"	160	100	.85"	.984"	1.70"	.748"

Load limits are for fasteners only. Attachment to structure must be evaluated separately

FEATURES

- Rotatable joint ensures rod maintains a vertical position
- Galvanized bracket

APPLICATION

- Mounts to wood or concrete structures to suspend threaded rods

MATERIAL/FINISH

- Spring Steel/GEOSEAL™

CERTIFICATIONS

- UL Standard: UL 2239



WALL MOUNT, THREADED ROD HANGER



R014T

PART #	FOR ROD SIZE	BOX QTY.
R014T	1/4" - 20	100
R038T	3/8" - 16	100

FEATURES

- Design allows threaded rods to be added quickly and easily to any overhead structure

APPLICATION

- Threaded rod support brackets are used to suspend #8 wires, and 1/4" plain or threaded rods from wood or metal overhead structures

MATERIAL/FINISH

- Black oxide/Zinc plated steel

QUICK SHOT, THREADED HANGER CLIPS



TRH-1420

PART #	SIZE	BOX QTY.
TRH-1420	1/4" – 20	100
TRH-3816	3/8" – 16	100

FEATURES

- Included pre-set concrete nail

APPLICATION

- Quick shot threaded rod hanger is used to suspend all threaded rods quickly and easily to any overhead structure

QUICK SHOT, THREADED ROD COUPLER HANGER



STF14

PART #	DESCRIPTION	SIZE	BOX QTY.
STF14	PRE-ASSEMBLED WITH CONCRETE NAIL AND WASHER	1/4" – 20	6"

FEATURES

- Quickly installs with most powder actuated guns (similar to Ramset)
- Pre-assembled with concrete nail and washer
- Included threaded coupler to easily attach any length 1/4" – 20 all threaded rod

APPLICATION

- Use to install overhead all threaded rod support in concrete, masonry or metal ceiling applications

WITH SLOCK ROD ASSEMBLY



STF0030

FEATURES

- Included pre-set concrete nail

APPLICATION

- Quick shot threaded rod hanger is used to suspend all threaded rods quickly and easily to any overhead structure

PART #	DESCRIPTION	DROP ROD THREAD	OVERALL LENGTH	BOX QTY.
STF0030	PRE-ASSEMBLED WITH CONCRETE NAIL AND WASHER	1/4" DIAMETER, NO THREADS	30"	50
STF0036		1/4" DIAMETER, NO THREADS	36"	50



QUICK SHOT, THREADED ROD COUPLER HANGER WITH ALL THREADED ROD ASSEMBLY



STF1424

FEATURES

- Pre-assembled with concrete nail and washer
- Two 1/4" mounting hex nuts included
- Will shoot into metal, concrete or masonry using standard power actuated gun (similar to Ramset)

APPLICATION

- Use to install all threaded rod overhead support in concrete, masonry or metal ceiling applications
- All threaded rod included with hanger
- Use to mount and support many electrical boxes, enclosures and lighting fixtures

PART #	DESCRIPTION	DROP ROD THREAD	OVERALL LENGTH	BOX QTY.
STF1430	PRE-ASSEMBLED WITH CONCRETE NAIL AND WASHER	1/4" - 20	30"	50
STF1436			36"	50

QUICK SCREW, THREADED ROD COUPLER



STF14NP

FEATURES

- .74" mounting hole

APPLICATION

- Screw mount angled mounting couplers allows all threaded rod length to be quickly and easily affixed to any overhead surface (mounting hardware not included)

MATERIAL/FINISH

- Steel/Galvanized

PART #	INCLUDED COUPLER THREAD	OVERALL LENGTH	BOX QTY.
STF14NP	1/4" - 20	6"	50

THREADED ROD BRACKET

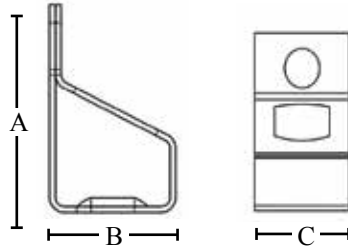

6TITZ



FEATURES

- 1/4" plain mounting hole

APPLICATION

- Mounts to wood or concrete structures to suspend threaded rods or wire

MATERIAL/FINISH

- Spring Steel/GEOSEAL™

CERTIFICATIONS

- UL Standard: UL 2239

PART #	THREAD SIZE	STATIC LOAD (LBS.)	A	B	C	BOX QTY.
4TITZ	1/4" THREADED	160	1.40"	.85"	.748"	100
6TTZ	3/8" PLAIN	160	1.40"	.85"	.748"	100
6TITZ	3/8" THREADED	160	1.40"	.85"	.748"	100

Load limits are for fasteners only. Attachment to structure must be evaluated separately.



MULTI-FUNCTION CLIPS



4Z34TZ

4Z4STZ

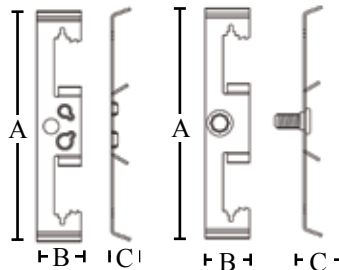

FEATURES

- Supports #10-24 and 1/4"-20 Bridle rings
- Spring steel tightening feature secures clip without addition hardware
- Use with other Southwire fasteners to create multiple cable and conduit support solutions

APPLICATION

- Easily installs on flanges, rods, and wire to support boxes or conduit

MATERIAL/FINISH

- Spring Steel/GEOSEAL™

CERTIFICATIONS

- UL Standard: UL 2239

PART #	FLANGE THICKNESS	ROD SIZE	WIRE SIZE	HOLE SIZE	SCREW SIZE	LOAD CAPACITY (LBS.)		A	B	C	BOX QTY.
						VERTICAL	HORIZONTAL				
4Z34TZ	1/8" - 3/8"	1/4"	#12 - #8	1/4"	NONE	25	15	3.87"	.748"	.315"	100
4Z4STZ	1/8" - 3/8"	1/4"	#12 - #8	---	1/4" - 20	25	15	3.87"	.748"	.315"	100
6Z34TZ	3/8" - 7/16"	3/8"	---	1/4"	NONE	25	15	3.62"	.748"	.315"	100

FASTENERS/ HARDWARE



METAL STUD GROMMETS



ESG1TZ

45TZ



Common hole configurations in metal studs

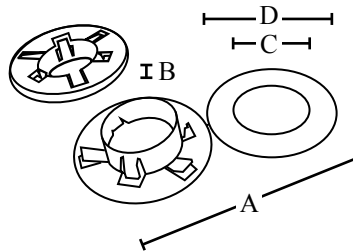

PART #	BOX QTY.	A	B	C	D
ESG1TZ	100	4.61"	.56"	1.35"	2.27"
ESG1MTZ	1000	4.61"	.56"	1.35"	2.27"
45TZ	200	4.61"	.56"	1.35"	2.27"

FEATURES

- Tool free installation
- Provides 360° protection for cables
- Makes pulling cables easier
- Fits all stud hole sizes
- Snaps in over different hole configurations for protection from sharp metal

APPLICATION

- Universal metal stud grommets are used to protect wires from damage caused by sharp edges on metal studs

MATERIAL/FINISH

- 6/6 Nylon

CERTIFICATIONS

- UL Standard: UL514B



HANGING AND SUPPORT

WIRETAB™ CABLE POSITIONING DEVICE



MWT1

PART #	TRADE SIZE	BOX QTY.
MWT1	1 GANG	25

APPLICATION

- Hold loose end of wire in position during construction.
- Ideal for under cabinet lights, security, doorbells, speakers and more

FEATURES

- WireTab™ Cable Positioning Device hugs the corner of a wall stud, allowing loose wire ends to be threaded through the channel
- When drywall is hung, a pre-cut hole is positioned to surround the WireTab™ Cable
- Positioning Device channel so wire ends are in the correct place

MATERIAL/FINISH

- Polyethylene/Yellow

END CAPS FOR STRUT CHANNEL



SFEC08

APPLICATION

- To cap off end of strut channel

MATERIAL/FINISH

- White Plastic

PART #	FOR CHANNEL	BOX QTY.
SFEC08	13/16" X 1-5/8"	100
SFEC09	1-5/8" X 1-5/8"	100

FLAT SPLICE PLATES



SFF30

FEATURES

- 1/4" thick steel

APPLICATION

- Use to secure two pieces of strut channel together
- SFF34 is used for parallel/side by side strut attachment

MATERIAL/FINISH

- Steel/Electroplated zinc

PART #	NUMBER OF HOLES	TYPE	BOX QTY.
SFF30	2	END SPLICE	50
SFF31	3	END SPLICE	25
SFF32	4	END SPLICE	25
SFF34	2	PARALLEL SPICE	25

3 HOLE FLAT SPLICE PLATES CORNER



SFF50-GN

FEATURES

- 1/4" thick steel

APPLICATION

- Use to secure two pieces of strut channel at a 90° angle

MATERIAL/FINISH

- Steel/Green powder coat or Electroplated zinc

PART #	HOLE DIAMETER	HOLE CENTER TO CENTER	FINISH	BOX QTY.
SFF50-GN	9/16"	1-7/8"	GREEN POWDER COAT	25
SFF50	9/16"	1-7/8"	ZINC PLATED	25

4 HOLE FLAT SPLICE PLATES CORNER



SFF51-GN

FEATURES

- 1/4" thick steel

APPLICATION

- Use to secure two pieces of strut channel at a 90° angle

MATERIAL/FINISH

- Steel/Green powder coat or Electroplated zinc

PART #	HOLE DIAMETER	HOLE CENTER TO CENTER	FINISH	BOX QTY.
SFF51-GN	9/16"	1-7/8"	GREEN POWDER COAT	20
SFF51	9/16"	1-7/8"	ZINC PLATED	20

4 HOLE FLAT SPLICE PLATES TEE

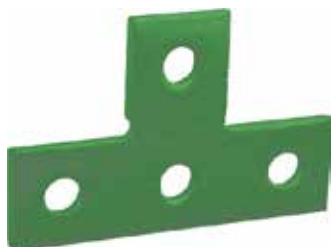

SFF60-GN

FEATURES

- 1/4" thick steel

APPLICATION

- Use to secure two pieces of strut channel at a 90° angle

MATERIAL/FINISH

- Steel/Green powder coat or Electroplated zinc

PART #	HOLE DIAMETER	HOLE CENTER TO CENTER	FINISH	BOX QTY.
SFF60-GN	9/16"	1-7/8"	GREEN POWDER COAT	20
SFF60	9/16"	1-7/8"	ZINC PLATED	20

2 HOLE 90° ANGLE CORNER BRACKET



SFL11-GN

FEATURES

- Legs: 2" x 1-7/8" * 1/4" thick steel

APPLICATION

- Use to secure two pieces of strut channel at a 90° angle

MATERIAL/FINISH

- Steel/Green powder coat, Electroplated zinc, or 316 Stainless steel

PART #	HOLE DIAMETER	MATERIAL	FINISH	BOX QTY.
SFL11-GN	9/16"	STEEL	GREEN POWDER COAT	50
SFL11	9/16"	STEEL	ZINC PLATED	50
SFL11-SS	9/16"	316 STAINLESS STEEL	STAINLESS	50

TWO HOLE ANGLE BRACKET



ABTZ

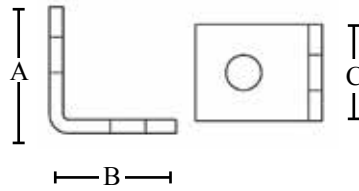

FEATURES

- 1/4" structural mounting hole

APPLICATION

- Provides attachment of rods, hooks, or chains from concrete or wood structure

MATERIAL/FINISH

- Steel/Galvanized or Stainless steel

CERTIFICATIONS

- UL Standard: UL 2239



PART #	MATERIAL	ROD SIZE	THROUGH HOLE SIZE		BOX QTY.	A	B	C
			SMALL HOLE	LARGE HOLE				
ABTZ	STEEL/GALVANIZED	1/4"	.250"	.250"	100	.984"	.984"	.748"
AB375TZ		3/8"	.280"	.280"	100	.984"	.984"	.748"
BA-1/4-SS	STAINLESS STEEL	1/4"	.250"	.385"	100	.984"	.984"	.748"
BA-3/8-SS		3/8"	.280"	.385"	100	.984"	.984"	.748"

TWO HOLE 90° ANGLE CROSS CORNER BRACKET



SFL20

FEATURES

- Legs: 2-1/4" x 1-5/8"
- 1/4" thick steel

APPLICATION

- Use to secure three pieces of strut channel at a 90° angle

MATERIAL/FINISH

- Steel/Electroplated zinc

PART #	HOLE DIAMETER	FINISH	BOX QTY.
SFL20	9/16"	ZINC PLATED	50

THREE HOLE 90° ANGLE CORNER BRACKET



SFL21

FEATURES

- Legs: 4-1/8" x 1-5/8"
- 1/4" thick steel

APPLICATION

- Use to secure two pieces of strut channel at a 90° angle

MATERIAL/FINISH

- Steel/Electroplated zinc

PART #	HOLE DIAMETER	FINISH	BOX QTY.
SFL21	9/16"	ZINC PLATED	25

FOUR HOLE 90° ANGLE CORNER BRACKET



L220000EGTZ



FEATURES

- Legs: 4-1/8" x 3-1/2"
- 1/4" thick steel

APPLICATION

- Use to secure two pieces of strut channel at a 90° angle

MATERIAL/FINISH

- Steel/Galvanized or 316 Stainless steel

PART #	MATERIAL	HOLE DIAMETER	BOX QTY.
L220000EGTZ	STEEL/GALVANIZED	9/16"	25
SFL31-SS	316 STAINLESS STEEL	9/16"	25

FOUR HOLE CORNER 90° ANGLE BRACKET



SFL13-GN

FEATURES

- Legs: 3-7/8" x 3-3/4"
- 1/4" thick steel

APPLICATION

- Use to secure two pieces of strut channel at a 90° angle

MATERIAL/FINISH

- Steel/Green powder coat, Electroplated zinc, or 316 Stainless steel

PART #	HOLE DIAMETER	MATERIAL	FINISH	BOX QTY.
SFL13-GN	9/16"	STEEL	GREEN POWDER COAT	25
SFL13	9/16"	STEEL	ZINC PLATED	25

THREE HOLE CORNER 90° ANGLE BRACKET



SFL30

FEATURES

- Legs: 3-1/2" x 2-1/4"
- 1/4" thick steel

APPLICATION

- Use to secure two pieces of strut channel at a 90° angle

MATERIAL/FINISH

- Steel/Electroplated zinc

PART #	HOLE DIAMETER	FINISH	BOX QTY.
SFL30	9/16"	ZINC PLATED	25

TWO HOLE CORNER 45° ANGLE BRACKET



SFL60

FEATURES

- 1/4" thick steel

APPLICATION

- Use to secure two pieces of strut channel at a 45° angle

MATERIAL/FINISH

- Steel/Green powder coat or Electroplated zinc

PART #	HOLE DIAMETER	FINISH	BOX QTY.
SFL60-GN	9/16"	GREEN POWDER COAT	25
SFL60	9/16"	ZINC PLATED	25

FOUR HOLE CORNER 45° ANGLE BRACKET



SFL62

FEATURES

- 1/4" thick steel

APPLICATION

- Use to secure two pieces of strut channel at a 45° angle

MATERIAL/FINISH

- Steel/Electroplated zinc

PART #	HOLE DIAMETER	FINISH	BOX QTY.
SFL62	9/16"	ZINC PLATED	25

U-FITTING SPLICE

EXTERNAL, FOUR HOLE



SFU33-GN

FEATURES

- 1/4" thick steel

APPLICATION

- Use to secure two pieces of strut channel

MATERIAL/FINISH

- Steel/Green powder coat or Electroplated zinc

PART #	FOR CHANNEL DEPTH	HOLE DIAMETER	LENGTH	FINISH	BOX QTY.
SFU33-GN	13/16"	9/16"	7-1/4"	GREEN POWDER COAT	10
SFU33	13/16"	9/16"	7-1/4"	ZINC PLATED	10
SFU32-GN	1-5/8"	9/16"	7-1/4"	GREEN POWDER COAT	10
SFU32	1-5/8"	9/16"	7-1/4"	ZINC PLATED	10

STRUT JOINER INTERNAL

WITH CAM SCREWS



SFEF33-1316

APPLICATION

- Use to secure two pieces of strut channel

MATERIAL/FINISH

- Steel/Electroplated zinc

PART #	FOR CHANNEL DEPTH	LENGTH	FINISH	BOX QTY.
SFEF33-1316	13/16"	4-7/16"	ZINC PLATED	10
SFEF33-158	1-5/8"	4-7/16"	ZINC PLATED	10

WALL BRACKET CHANNEL

FOR 1-5/8" STRUT



SFBR40-6

FEATURES

- 1/4" thick steel

APPLICATION

- Use as shelf or to hang other apparatuses

MATERIAL/FINISH

- Steel/Electroplated zinc

PART #	DESCRIPTION	LENGTH	UNIFORM LOAD CAPACITY (LBS.)	BOX QTY.
SFBR40-6	2 MOUNTING HOLES	6"	1,250	1
SFBR40-9	3 MOUNTING HOLES	9"	1,000	1
SFBR40-12	4 MOUNTING HOLES	12"	750	1

TWO HOLE POST BASE

6" X 4"



SFP10

PART #	DESCRIPTION	CHANNEL SIZE	FINISH	BOX QTY.
SFP10	PARALLEL TO EDGE	1-5/8"	ZINC PLATED	5

FEATURES

- 1/4" thick steel

APPLICATION

- Use to secure strut channel to floor or flat surface

MATERIAL/FINISH

- Steel/Electroplated zinc

FOUR HOLE POST BASE

6" X 6"



SFP14-GN

PART #	DESCRIPTION	CHANNEL SIZE	FINISH	BOX QTY.
SFP14-GN	PARALLEL TO EDGE	1-5/8"	GREEN POWDER COAT	5
SFP14	PARALLEL TO EDGE	1-5/8"	ZINC PLATED	5
SFP13	TURNED 45° TO EDGE	1-5/8"	ZINC PLATED	5

FEATURES

- 1/4" thick steel

APPLICATION

- Use to secure strut channel to floor or flat surface

MATERIAL/FINISH

- Steel/Green powder coat or Electroplated zinc

RMC U-BOLT WITH HEX NUTS

HOT DIP GALVANIZED



761HDG

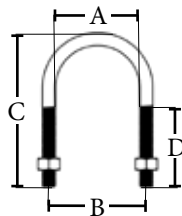

FEATURES

- Hot dip galvanized zinc plating over malleable iron for added durability and corrosion protection

APPLICATION

- U-Bolts secure conduit to a beam or channel

MATERIAL/FINISH

- Malleable iron/Hot dip galvanized

PART #	SIZE	BOLT SIZE	INNER QTY.	MASTER QTY.	A	B	C	D
761HDG	1/2"	5/16" – 18	25	250	.97"	1.24"	2.46"	1.50"
762HDG	3/4"	5/16" – 18	25	250	1.15"	1.43"	2.76"	1.50"
763HDG	1"	5/16" – 18	25	250	1.42"	1.70"	3.01"	1.50"
764HDG	1-1/4"	5/16" – 18	20	200	1.79"	2.07"	3.16"	1.50"
765HDG	1-1/2"	5/16" – 18	20	200	2.04"	2.32"	3.52"	1.50"
766HDG	2"	3/8" – 16	10	100	2.49"	2.83"	4.39"	1.96"
767HDG	2-1/2"	3/8" – 16	---	20	3.06"	3.39"	4.75"	1.96"
768HDG	3"	3/8" – 16	---	20	3.65"	3.98"	5.38"	1.96"
769HDG	3-1/2"	3/8" – 16	---	20	4.21"	4.55"	5.76"	1.96"
770HDG	4"	3/8" – 16	---	20	4.69"	5.03"	6.27"	1.96"

STRUT TO BEAM CLAMP WITH BOLT



SFBC60

FEATURES

- 3/8"–16 threads

APPLICATION

- Use to secure strut channel to underside of a beam

MATERIAL/FINISH

- Steel/Electroplated zinc

PART #	FOR HEIGHT CHANNEL	MAX FLANGE THICKNESS	MAX LOAD (LBS.) USED IN PAIRS	BOX QTY.
SFBC60	13/16" or 1-5/8"	3/4"	1,200	25
SFBC61	2-7/16" or 3-1/4"	3/4"	1,200	25

HANGING AND SUPPORT

STRUT TO BEAM WINDOW CLAMP

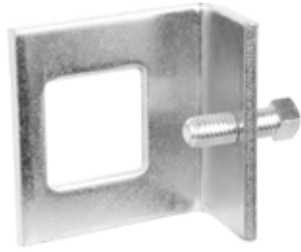

SFBC40

FEATURES

- 1/4" thick steel

APPLICATION

- Use to secure strut channel to floor or flat surface

MATERIAL/FINISH

- Steel/Electroplated zinc

PART #	FOR CHANNEL	MAX LOAD (LBS.) USED IN PAIRS	MATERIAL	BOX QTY.
SFBC40	1-5/8" x 1-5/8"	950	ZINC PLATED STEEL	20

STRUT TO BEAM NOTCHED CLAMP



SFBC70

FEATURES

- 1/4" thick steel
- 1/2"-13 HHCS and 1/2" channel nut sold separately

APPLICATION

- Use to secure strut channel to the underside of a structural beam in tight spaces
- Use in conjunction with spring nuts or cone nuts to securely fasten the strut to the beam surface

MATERIAL/FINISH

- Steel/Electroplated zinc

PART #	FOR CHANNEL	MAX LOAD (LBS.) USED IN PAIRS	BOX QTY.
SFBC70	13/16" x 1-5/8"	1,100	25

BAR-JOIST WASHERS



23WBJ

APPLICATION

- Bar joist washers clamp on open web bar joist trusses and allow for multiple items to be hung along ceiling joists
- Bar joist washers allow the installer to easily mount boxes, hangers and clamps anywhere along linear open bar joist grid

MATERIAL/FINISH

- Steel/Electroplated zinc

PART #	FOR ROD OR BOLT SIZE	BOX QTY.
23WBJ	1/4"	50
24WBJ	3/8"	50

SWIVEL, MALE/FEMALE



SFSW13-3816

PART #	THREAD	MAX LOAD CAPACITY (LBS.)	BOX QTY.
SFSW13-3816	3/8" – 16	620	50
SFSW13-1213	1/2" – 13	1,150	50

FEATURES

- Allows for straight, flush hang

APPLICATION

- Use as a union between two supports or pieces of all threaded rod

MATERIAL/FINISH

- Steel/Electroplated zinc

SWIVEL, FEMALE/FEMALE



SFSW12-3816

PART #	THREAD	MAX LOAD CAPACITY (LBS.)	BOX QTY.
SFSW12-3816	3/8" – 16	620	50
SFSW12-1213	1/2" – 13	1,150	50

FEATURES

- Allows for straight, flush hang

APPLICATION

- Use as a union between two supports or pieces of all threaded rod

MATERIAL/FINISH

- Steel/Electroplated zinc

THREADED ROD HANGERS



SMY142W



SMY141S

FEATURES

- Direct mount into support surface

APPLICATION

- Threaded rod hangers are specifically designed to be used in overhead applications to provide tapped 1/4"-20 or 3/8"-16 threaded rod attachment points

MATERIAL/FINISH

- Steel/Zinc plated

PART #	OVERALL LENGTH	APPLICATION	FOR ROD SIZE	BOX QTY.
SMY142W	2"	FOR WOOD	1/4" – 20	10
SMY382W	2-1/2"	FOR WOOD	3/8" – 16	10
SMY141C	2"	FOR MASONRY/BRICK	1/4" – 20	10
SMY381C	2-1/2"	FOR MASONRY/BRICK	3/8" – 16	10
SMY141S	1"	FOR SHEET METAL	1/4" – 20	10
SMY381S	1"	FOR SHEET METAL	3/8" – 16	10



SLIP-TIGHT THREADED ROD NUT



SLN-3816

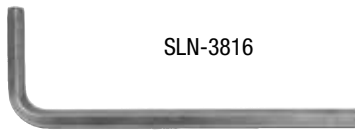

FEATURES

- Secure nut in place with Allen wrench

APPLICATION

- Slip-tight threaded rod nut has ability to be positioned on threaded rod or bolt at any point, without the time consuming nuisance of threading

MATERIAL/FINISH

- Steel/Zinc plated

PART #	FOR ROD SIZE	BOX QTY.
SLN-3816	3/8" – 16	100

SPLIT NUT



SN37TZ

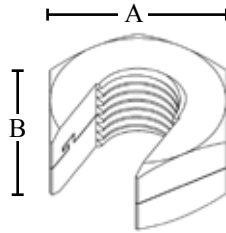

FEATURES

- Allows user to start threading at any point along the threaded rod
- Allows user to avoid damaged threads
- Strong load ratings

APPLICATION

- Southwire's Split Nuts reduce the time for threading a rod compared to conventional nuts

MATERIAL/FINISH

- Steel/Galvanized

PART #	ROD SIZE	A	B	BOX QTY.
SN25TZ	1/4"-20	0.64"	0.35"	100
SN37TZ	3/8"-16	0.86"	0.49"	100
SN50TZ	1/2"-13	1.05"	0.63"	100



TOP SPRING NUT



TSNT0037EGTZ

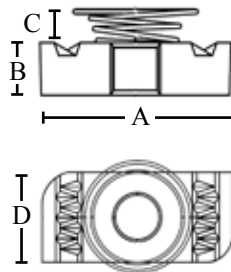

FEATURES

- Spring diameter 1.10"
- Grooved attachment nut creates a secure fit and improves traction

APPLICATION

- Manufactured for slip resistant support of components in strut system

MATERIAL/FINISH

- Steel/Galvanized



PART #	ROD SIZE	TORQUE FORCE (LBS.)	BOX QTY.	A	B	C	D
TSNT0025EGTZ	1/4"	13	100	1.35"	.208"	.223"	.729"
TSNT0037EGTZ	3/8"	22	100	1.36"	.345"	.223"	.75"

STRUT NUTS WITH SPRING

FOR STRUT CHANNEL



SNSS1420



2111

FEATURES

- Teeth to bite into inside lip of strut
- SNSSXXXX - short spring
- SNLSXXXX - long spring
- 211X - standard length

APPLICATION

- Secures fittings or other apparatus to strut system

MATERIAL/FINISH

- Steel/Electroplated zinc

PART #	FOR CHANNEL DEPTH	HOLE THREAD	BOX QTY.
SNSS1420	13/16" TO 1"	1/4" - 20	50
SNSS3816	13/16" TO 1"	3/8" - 16	50
SNSS1213	13/16" TO 1"	1/2" - 13	50
2111	1-3/8" TO 1-5/8"	1/4" - 20	100
2112	1-3/8" TO 1-5/8"	3/8" - 16	100
2113	1-3/8" TO 1-5/8"	1/2" - 13	50
SNLS1420	2-7/16" TO 3-1/4"	1/4" - 20	50
SNLS3816	2-7/16" TO 3-1/4"	3/8" - 16	50
SNLS1213	2-7/16" TO 3-1/4"	1/2" - 13	50

SELF-TAPPING SCREW



SMS8TZ

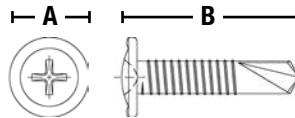

FEATURES

- Self-drilling and tapping
- Low profile Phillips head #8, 1/2"

APPLICATION

- Supports metal box brackets to studs
- Low profile screw head reduces sheet rock bulge

MATERIAL/FINISH

- Steel/Galvanized

PART #	BOX QTY.	A	B
SMS8TZ	1000	.414	.500

BOTTOM SPRING NUT



SPRA0037EGTZ

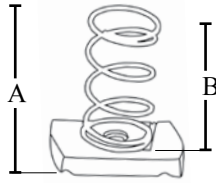

FEATURES

- Grooved attachment nut creates secure fit and improves traction
- For use with 1-5/8" strut channel

APPLICATION

- Manufactured for slip resistant support of components in strut system

MATERIAL/FINISH

- Steel/Galvanized

PART #	CHANNEL TYPE	ROD SIZE	TORQUE FORCE (LBS.)	NUT THICKNESS
SPRA0025EGTZ	A & B	1/4" – 20	13	.21"
SPRA0037EGTZ	A & B	3/8" – 16	22	.34"
SPRA0050EGTZ	A & B	1/2" – 13	40	.449"
SPRC0025EGTZ	C	1/4" – 20	13	.222"

PART #	BOX QTY.	A	B	C	D
SPRA0025EGTZ	100	1.79"	1.58"	1.35"	.741"
SPRA0037EGTZ	100	1.95"	1.61"	1.35"	.72"
SPRA0050EGTZ	100	2.02"	1.57"	1.34"	.747"
SPRC0025EGTZ	100	1"	.778"	1.35"	.73"



HANGING AND SUPPORT

STRUT NUT, NO SPRING

FOR STRUT CHANNEL



CNN-038



FEATURES

- Teeth to bite into inside lip of strut

APPLICATION

- Secures fittings or other apparatus to strut system

MATERIAL/FINISH

- Steel/Electroplated zinc

CERTIFICATIONS

- UL Listed

PART #	HOLE THREAD	BOX QTY.
CNN-025	1/4" – 20	100
CNN-038	3/8" – 16	100
SNW01213	1/2" – 13	50

CONE NUT

FOR STRUT CHANNEL



SNCN1420

FEATURES

- Push and turn easy installation
- Teeth to bite into inside lip of strut

APPLICATION

- Secures fittings or other apparatus to strut system

MATERIAL/FINISH

- Steel/Electroplated zinc

PART #	HOLE THREAD	BOX QTY.
SNCN1420	1/4" – 20	100
SNCN3816	3/8" – 16	100
SNCN1213	1/2" – 13	100

SQUEEZE NUT

FOR STRUT CHANNEL



SNSQ1420

FEATURES

- Push and turn easy installation
- Teeth to bite into inside lip of strut

APPLICATION

- Secures fittings or other apparatus to strut system

MATERIAL/FINISH

- Steel/Electroplated zinc

PART #	HOLE THREAD	BOX QTY.
SNSQ1420	1/4" – 20	100
SNSQ3816	3/8" – 16	100
SNSQ1213	1/2" – 13	100

SQUARE CHANNEL WASHER



F130000EGTZ

PART #	ROD SIZE	HOLE DIAMETER	BOX QTY.
F130000EGTZ	5/16"	3/8"	100
F140000EGTZ	3/8"	7/16"	100
F150000EGTZ	1/2"	9/16"	100

APPLICATION

- Secures rods to strut channel

MATERIAL/FINISH

- Steel/Galvanized



STRUT WASHERS

"U/SADDLE" STYLE



SFU70-25

PART #	BOLT SIZE	BOX QTY.
SFU70-25	1/4" - 20	50
SFU70-38	3/8" - 16	50
SFU70-50	1/2" - 13	50

FEATURES

- Saddle design prevents twisting or movement of washer

APPLICATION

- Use to secure all threaded rod to strut system

MATERIAL/FINISH

- Steel/Electroplated zinc

STRUT WASHERS

1-5/8" SQUARE STANDARD



SW-1/4-SS

FEATURES

- 1/4" thick steel

APPLICATION

- Use to secure all threaded rod to strut system

MATERIAL/FINISH

- Steel/Green powder coat finish, Electroplated zinc, or 316 Stainless steel

PART #	BOLT SIZE	FINISH	BOX QTY.
SW-1/4-G	1/4"	GREEN POWDER COAT	100
SW-3/8-G	3/8"		100
SW-1/2-G	1/2"		100
SW-5/8-G	5/8"		100
SW-1/4	1/4"	ZINC PLATED	100
SW-3/8	3/8"		100
SW-1/2	1/2"		100
SW-5/8	5/8"		100
SW-3/4	3/4"		100
SW-1/4-SS	1/4"	316 STAINLESS STEEL	100
SW-3/8-SS	3/8"		100
SW-1/2-SS	1/2"		100
SW-5/8-SS	5/8"		100

2" SQUARE, EXTRA LARGE



SW-2-3/8

FEATURES

- 1/4" thick steel

APPLICATION

- Use to secure all threaded rod to strut system

MATERIAL/FINISH

- Steel/Electroplated zinc

PART #	BOLT SIZE	FINISH	BOX QTY.
SW-2-3/8	3/8"	ZINC PLATED	100
SW-2-1/2	1/2"		100
SW-2-5/8	5/8"		100
SW-2-3/4	3/4"		100

STRUT WASHERS

1-5/8" SQUARE, NOTCHED



SFF20

PART #	BOLT SIZE	FINISH	BOX QTY.
SFF20	1/4"	ZINC PLATED	100
SFF21	3/8"		100
SFF22	1/2"		100
SFF23	5/8"		100
SFF24	3/4"		100

FEATURES

- Notched design prevents twisting or movement of washer
- 1/4" thick steel

APPLICATION

- Use to secure all threaded rod to strut system

MATERIAL/FINISH

- Steel/Electroplated zinc

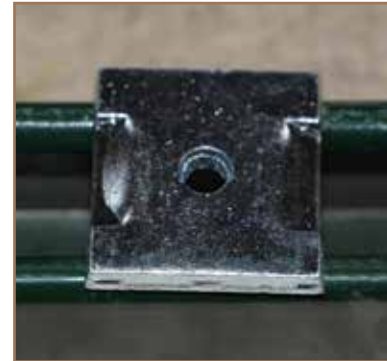

FLAT OCTAGON



12WFS

PART #	BOLT SIZE	FINISH	BOX QTY.
12WFS	1/4" OR 3/16"	ZINC PLATED STEEL	100
13WFS	1/2"		100
14WFS	3/8"		100
12WFSS	1/4" OR 3/16"	316 STAINLESS STEEL	100
13WFSS	1/2"		100
14WFSS	3/8"		100

FEATURES

- 1-3/8" O.D.
- Mounts inside strut channel

APPLICATION

- Use to secure all threaded rods to strut system

MATERIAL/FINISH

- Steel/Electroplated zinc or 304 Stainless steel

STUD/ DRYWALL

**Support and protection for electrical
circuits through termination within
the structure**

BOX SUPPORT SYSTEMS

CABLE/CONDUIT SUPPORT

NAIL PLATES

BOX SUPPORT SYSTEMS



FLOOR MOUNT BOX SUPPORT



FMBS18TZ

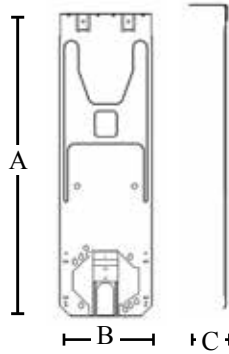

PART #	A	B	C	BOX QTY.
FMBS18TZ	21.06"	6.48"	2.56"	25

FEATURES

- Mounts inside or under wall stud tracks
- Built-in back support
- Meets ADA guidelines for 15" height minimum

APPLICATION

- Provides versatility in positioning electrical boxes in between wall studs

MATERIAL/FINISH

- Steel/Galvanized

CERTIFICATIONS

- UL Standard: UL 514A



SNAP-ON BOX SUPPORT



MSFTZ

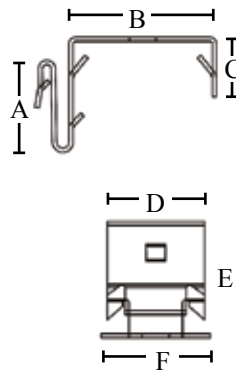

PART #	A	B	C	D	E	F	BOX QTY.
MSFTZ	.962"	1.54"	.622"	1"	1.20"	1.12"	100

FEATURES

- Snaps on to metal/wood studs
- Clips onto box
- Center hole allows for screw attachment

APPLICATION

- Clip-on feature easily attaches electrical boxes to studs

MATERIAL/FINISH

- Spring Steel/GEOSEAL™

CERTIFICATIONS

- UL Standard: UL 2239



STEEL BOX SUPPORT



DSI2ATZ

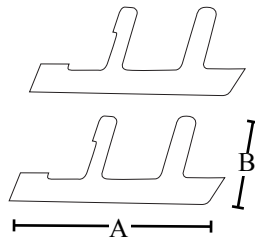

PART #	A	B	BOX QTY.
DSI2ATZ	5.125"	2.25"	50

FEATURES

- Break apart design for easy handling
- Sold in pairs

APPLICATION

- Bendable, easy-to-use tabs secure metal boxes in drywall, lath, and plaster

MATERIAL/FINISH

- Steel



BOX MOUNTING BRACKET

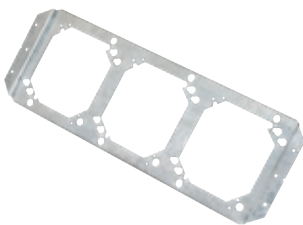

RBS16TZ

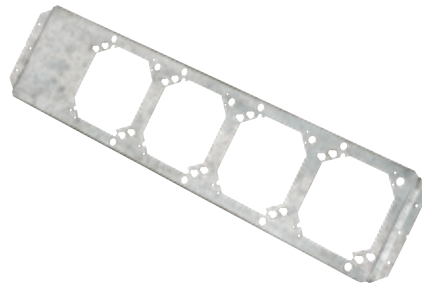

RBS24TZ

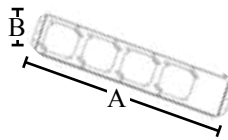
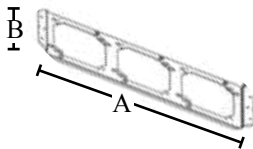

PART #	STUD SPACING	A	B	BOX QTY.
RBS16TZ	16"	16"	5"	20
RBS24TZ	24"	24"	5"	20

FEATURES

- For use with 4" & 4-11/16" outlet boxes
- Suitable for 1-1/2" & 2-1/8" deep boxes
- Supports single or multiple boxes, plaster rings or low voltage devices

APPLICATION

- Secures multiple boxes between studs using one bracket; 16" supports up to 3 boxes and 24" supports up to 4 boxes

MATERIAL/FINISH

- Steel/Galvanized

CERTIFICATIONS

- UL Standard: UL514A



BOX MOUNTING BRACKET 3-POSITION FOR ADJUSTABLE DEPTH DEVICE RINGS



BMB3U

FEATURES

- Mounts up to three boxes and Southwire adjustable device covers

APPLICATION

- Bracket is used to position three junction boxes with Southwire adjustable device rings between wood or metal studs

MATERIAL/FINISH

- Steel/Galvanized

PART #	ADJUST. DEPTH RING COMPATIBILITY	STUD CENTER DISTANCE	FITS SQUARE BOXES	BOX QTY.
BMB3U	AMR1, AMR2, AMR0	16"	4", 4-11/16"	25

SCREW GUN BRACKETS



TSGB16TZ

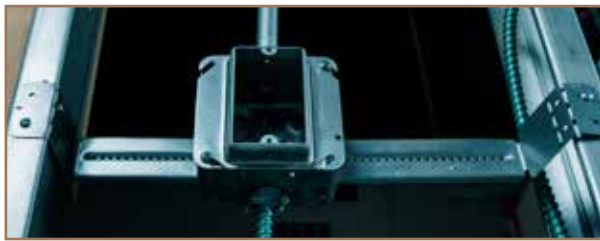

FEATURES

- Notched and marked allows for easy identification and bending
- Pilot holes for easy box attachment
- Adjustable version for non-standard stud spacing
- Mounting holes length of bar for easy box installation
- 13 lbs. load capacity when intended to support a fixture or luminaire in a wall

APPLICATION

- Screw gun brackets allow electrical boxes to be quickly and easily installed between ceiling joists or wall studs

MATERIAL/FINISH

- Steel/Galvanized

CERTIFICATIONS

- UL Standard: UL 514A*



PART #	SPAN	LENGTH	BOX DEPTHS	BOX QTY.
SGB16ATZ*	NON-ADJUSTABLE	16"	1-1/2", 2-1/8"	50
TSGB16TZ*	ADJUSTABLE	11-1/2" TO 17-3/4"	1-1/2", 2-1/8"	50
TSGB1624TZ*	ADJUSTABLE	14-1/4" TO 24-1/4"	1-1/2", 2-1/8", 2-1/2"	50
BHAD16**	ADJUSTABLE	11" TO 18"	3 - 3-1/2"	50
BHAD24**	ADJUSTABLE	17" TO 26"	3 - 3-1/2"	50

*cULus listed | **Not UL listed

TELESCOPING BOX SUPPORT



TSRBS1625TZ

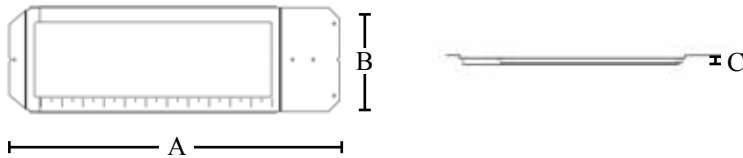

PART #	A	B	C	BOX QTY.
TSRBS1625TZ	17.56"	4.94"	.561"	25

FEATURES

- Telescoping feature accommodates studs from 16" to 24"
- Use with 4" square box and mud ring
- Will support 4 electrical boxes in 24" spacing
- Easily adjust box position after installed

APPLICATION

- Provides flexibility to support electrical boxes in-between wall studs

MATERIAL/FINISH

- Steel/Galvanized

CERTIFICATIONS

- UL Standard: UL 514A



SLIDER BOX BRACKET

FOR BOX MOUNTING BETWEEN STUDS

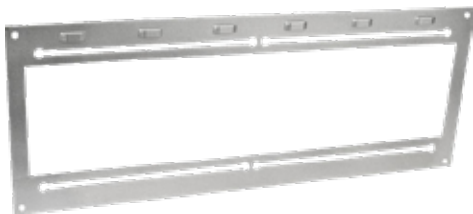

BMB16SL



PART #	STUD CENTER DISTANCE	FITS SQUARE BOXES	BOX QTY.
BMB16SL	16"	4", 4-11/16"	50
BMB616SL	16"	6"	50

FEATURES

- Full box adjustment left/right for exact placement of box/cover

APPLICATION

- Use to position a box with standard device ring between wood or metal studs

MATERIAL/FINISH

- Steel/Galvanized

CERTIFICATIONS

- UL Listed (exception BMB16SL)



SINGLE BOX MOUNTING BRACKET

FOR STANDARD DEVICE RINGS



BB4-26

PART #	FAR-SIDE STAND OFF	FITS SQUARE BOXES	BOX QTY.
BB4-26	2-1/2", 3-5/8"	4", 4-11/16"	25
BB6-26	2-1/2", 3-5/8"	6"	50

FEATURES

- Accepts 4", 4-11/16" and 6" square boxes and device rings
- Centering notch on face of bracket
- Either side of stud mount option

APPLICATION

- Universal box mounting brackets have a single stud face mount tab and can be used to support electrical boxes mounted on either side of a metal or wood stud
- Designed for use with standard device rings (mud rings)

MATERIAL/FINISH

- Steel/Galvanized

CERTIFICATIONS

- UL Listed

STUD MOUNTING BRACKETS

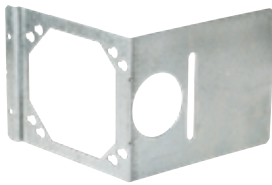

C6TZ



BMB1U

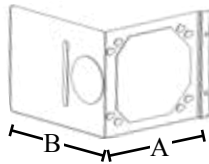
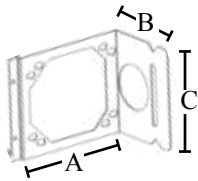

FEATURES

- Accepts 4" and 4-11/16" square boxes and adjustable device rings
- Centering notch on face of bracket

APPLICATION

- Universal box mounting brackets have a single stud face mount tab and can be used to support electrical boxes mounted to metal or wood studs
- Designed for use with Southwire adjustable device rings (mud rings)

MATERIAL/FINISH

- Steel/Galvanized

CERTIFICATIONS

- cULus Listed* or UL Listed**

PART #	WALL DEPTH	A	B	C	BOX QTY.
C6TZ*	2-1/2" TO 6"	3.50"	4.50"	5.625"	50
C23TZ*	2-1/2" TO 3-5/8"	5.875"	4.50"	5.625"	50
BB5-6	2-1/2", 3-5/8", 5-1/2", 6"	3.50"	4.50"	5.625"	50
BMB1U**	2-1/2" OR 3-5/8"	3.46"	5.38"	5.38"	50

*cULus listed | **Not UL listed



CABLE/CONDUIT SUPPORT



CONDUIT TO STUD ATTACHMENT CLAMP



6MFTZ

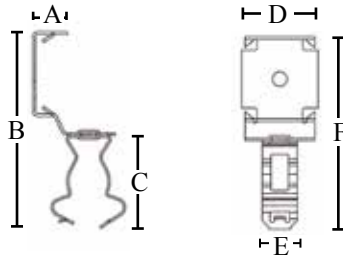

FEATURES

- Easily clips onto studs
- Stud clip size 1-3/8" to 1-1/2"
- Snap Close conduit support
- Screw hole feature allows clip to be screwed to stud for additional support

APPLICATION

- Conduit to stud attachment clamp easily secures conduit to studs without the need for tools

MATERIAL/FINISH

- Spring Steel/GEOSEAL™

CERTIFICATIONS

- UL Standard: UL 2239

PART #	EMT SIZE	FLEX CONDUIT SIZE	MC/AC CABLE SIZE	BOX QTY.	A	B	C	D	E	F
6MFTZ	---	3/8"	14-2 TO 12-3	100	.63"	1.53"	1.68"	1.38"	.63"	3.55"
16MFTZ	1/2" & 3/4"	---	---	100	.63"	1.53"	2.52"	1.38"	.63"	4.39"
20MFTZ	1"	---	---	50	.63"	1.53"	2.96"	1.38"	.63"	4.83"
812MFTZ	1-1/4"	---	---	100	.63"	1.53"	2.05"	1.38"	.63"	3.92"

HANGING AND SUPPORT

CABLE TO METAL STUD CLIP



449TZ

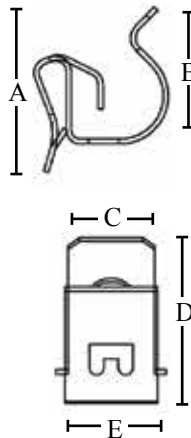

FEATURES

- Supports 14-3 to 12-3 MC/AC cables
- Easy no-tool installation

APPLICATION

- A quick and convenient solution to attach MC/AC cables to metal studs

MATERIAL/FINISH

- Spring Steel/GEOSEAL™

CERTIFICATIONS

- UL Standard: UL 2239



PART #	A	B	C	D	E	BOX QTY.
449TZ	.792"	.935"	.591"	1.13"	.63"	100

BOX SUPPORT BRACKET



766TZ

766ATZ

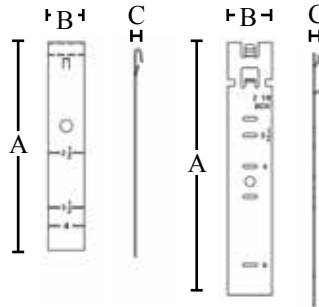

PART #	WALL DEPTH	BOX CLIP FEATURE	A	B	C	BOX QTY.
766TZ	2-1/2, 3-5/8, 4	SIDE WALL	4.29"	.752"	.168"	100
766ATZ	2-1/2, 3-1/2, 4, 6	SIDE HOLES	5.14"	.092"	.150"	100

FEATURES

- Easily clips to electrical boxes

APPLICATION

- Provides electrical box support for multiple wall depths

MATERIAL/FINISH

- Steel/Galvanized

CERTIFICATIONS

- UL Standard: UL 514A



CONDUIT TO STUD CLAMP



350812MTZ

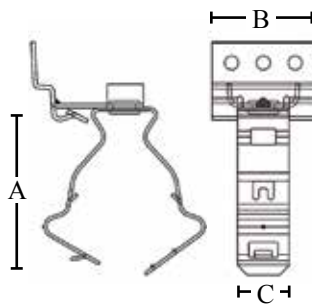

PART #	A	B	C	BOX QTY.
350812MTZ	2.05"	1.26"	.630"	100

FEATURES

- Supports 1/2" and 3/4" EMT
- Clip rotates 360° for easy positioning
- Secures to stud with screws
- Snap-close clip

APPLICATION

- Allows positioning of conduit to any size wood or metal studs

MATERIAL/FINISH

- Spring Steel/GEOSEAL™

CERTIFICATIONS

- UL Standard: UL 2239



CABLE/CONDUIT STUD CLIP



AR812TZ

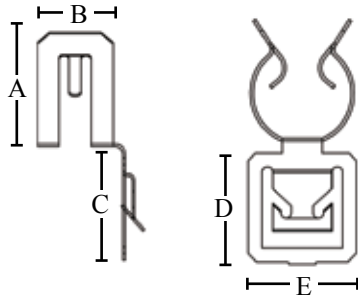

PART #	A	B	C	D	E	BOX QTY.
AR812TZ	1.13"	.748"	1.14"	1"	1"	100

FEATURES

- Supports 1/2", 3/4" EMT, 1/2" Rigid
- Reduces conduit rattling
- Snaps on to metal studs, no tools required

APPLICATION

- Provides support for EMT, Rigid, or MC/AC cables through metal studs

MATERIAL/FINISH

- Spring Steel/GEOSEAL™

CERTIFICATIONS

- UL Standard: UL 2239



MC, NM TO STUD WALL



CJ6TZ

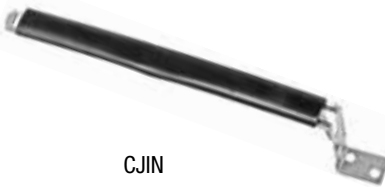

CJIN



PART #	CABLE SURFACE	LENGTH	BOX QTY.
CJ6TZ	STEEL	6"	100
CJIN	INSULATED RUBBER	6"	100

STUD TYPE	CABLE TYPE	CABLE SIZE	CABLES PER FASTENER
WOOD	NON-METALLIC	14-2, 12-2, 10-2, 14-3, 12-3, AND 10-3 WITH GROUND	MAX 6
		8 -2 AND 6-2 WITH GROUND	MAX 4
METAL STUD	METAL CLAD (MC)	14-2, 12-2, 10-2, 14-3, 12-3, 10-3, 14-4, 12-4, AND 10-4 WITH GROUND	MAX 4

FEATURES

- Supports up to 6 runs of NM sheathed cable or 4 runs of MC and AC cables
- Collapsible leg locks and secures cables for a snug fit
- Locating ribs to maintain cable separation

APPLICATION

- Easily installs to secure NM or MC cables to wood or metal studs
- Designed with a flared edge for maximum cable protection

MATERIAL/FINISH

- Steel/Zinc plated

CERTIFICATIONS

- UL Standard: UL 2239
- NEC® 300.4D applicable



NAIL STRAP CONDUIT SUPPORT

WOOD STUD MOUNT



DS1TZ

FEATURES

- Stamped teeth and pointed tip prevent accidental pull out

APPLICATION

- Secures EMT or Rigid/IMC conduit to wood stud or surface

MATERIAL/FINISH

- Stamped steel/Zinc plated

PART #	FOR EMT CONDUIT	FOR RIGID CONDUIT	INNER QTY.	BOX QTY.
DS1TZ	1/2"	3/8"	100	1000
DS2	3/4"	1/2"	100	1000
DS3	1"	3/4"	100	1000

CAST NAIL STRAP CONDUIT SUPPORT

WOOD STUD MOUNT



1600-CS

FEATURES

- 30% higher tensile strength vs. malleable iron
- Withstands greater striking force

APPLICATION

- Secures EMT or Rigid/IMC conduit to wood stud or surface

MATERIAL/FINISH

- Cast steel/Zinc plated

PART #	FOR EMT CONDUIT	FOR RIGID CONDUIT	INNER QTY.	BOX QTY.
1600-CS	1/2"	3/8"	100	1000
1605-CS	3/4"	1/2"	100	1000
1615-CS	1"	3/4"	100	1000

CABLE/CONDUIT TO STUD BRACKET



CS812TZ

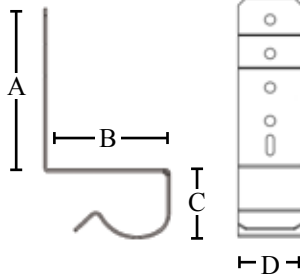

PART #	EMT SIZE	A	B	C	D	BOX QTY.
CS16TZ	1"	2.67"	2.07"	1.14"	1"	100
CS812TZ	1/2" & 3/4"	2.67"	1.42"	.811"	1"	100
CS812DTZ	1/2" & 3/4"	2.67"	2.04"	.811"	1"	100

FEATURES

- Supports 14-3 to 10-2 MC/AC cables
- Can be used on wood or metal studs

APPLICATION

- Provides a solution to attach EMT conduit or MC/AC cables to studs
- The multiple mounting holes allow for easy alignment of cable to junction box knockouts

MATERIAL/FINISH

- Spring Steel/GEOSEAL™

CERTIFICATIONS

- UL Standard: UL 2239



CLIP-ON CABLE TO STUD CLIP



FXC20TZ

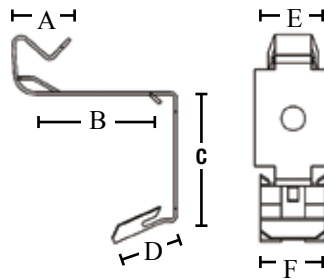

PART #	A	B	C	D	E	F	BOX QTY.
FXC20TZ	.672"	1.89"	1.50"	.745"	.882"	.752"	100

FEATURES

- Supports 14-2 to 12-3 MC/AC cables
- Includes screw mounting hole to provide additional support

APPLICATION

- Clips on to studs to provide a cable management solution for MC/AC cables.
- Results in a clean and professional installation

MATERIAL/FINISH

- Spring Steel/GEOSEAL™

CERTIFICATIONS

- UL Standard: UL 2239



SNAP-IN CABLE BRACKET



MAC2TZ

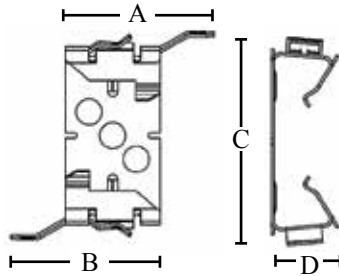

FEATURES

- Supports 14-2 to 10-3 MC/AC cables
- 1/8" max flange thickness
- Can be separated to create two separate clips
- Mounting holes allow for anchoring to wood, concrete or block

APPLICATION

- Clips onto flanges without tools or screws to wood, block, concrete, or metal studs
- Secures MC/AC cables to studs

MATERIAL/FINISH

- Spring Steel/GEOSEAL™

CERTIFICATIONS

- UL Standard: UL 2239



PART #	A & B	C	D	BOX QTY.
MAC2TZ	1.57"	1.967"	.647"	100

SCREW-ON CABLE TO STUD CLIP



MCS100TZ

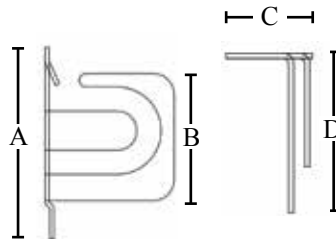

FEATURES

- Supports 14-3 to 10-2 MC/AC cables
- Can be used on metal or wood studs

APPLICATION

- Screws on to studs to provide a cable management solution for MC/AC cables
- Results in a clean and professional installation

MATERIAL/FINISH

- Steel/Galvanized

CERTIFICATIONS

- UL Standard: UL 2239



PART #	A	B	C	D	BOX QTY.
MCS100TZ	3.66"	2.42"	1.29"	2.46"	100

PANEL BRACKET 16"



PBTS16

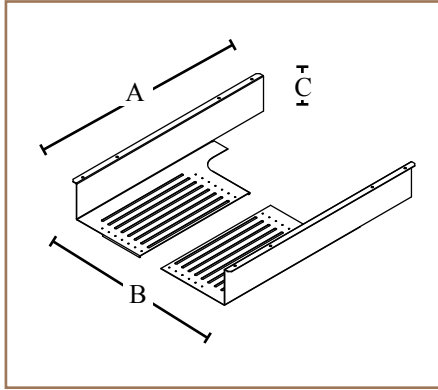
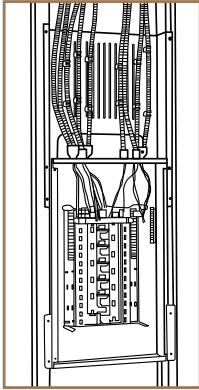

FEATURES

- Provide a rigid surface to easily secure flexible conduit cables
- Great solution for contractors wanting to pre-fab panel boxes
- Secure and protect cables during assembly, shipping and installation
- Saving time and labor assembly
- Compatible with the Southwire 449TZ MC/AC cable clip for securing
- 14-2 to 12/3 MC/AC cables to panel bracket. All other cables can be attached by other means

APPLICATION

- Between stud cable support mounting bracket

MATERIAL/FINISH

- Galvanized steel

PART #	A	B	C	BOX QTY.
PBTS16	21.38"	16"	3.6"	100

CABLE STAPLES



183

PART #	CABLE RANGE	SIZE	INNER QTY	MASTER QTY
183	ARMORED CABLE 14/2 & 14/3	1/2"	100	5000
184	METAL CLAD CABLE 14/2 & 14/3	1/2"	500	5000
185	NONMETALLIC SHEATHED 14/2 THROUGH 10/3 UNDERGROUND FEEDER 14/2 & 14/3	1/2"	BUCKET	5000
193	ARMORED CABLE 14/2 THROUGH 10/3	9/16"	100	5000
194	METAL CLAD CABLE 14/2 THROUGH 10/3	9/16"	500	5000
195	NONMETALLIC SHEATHED 12/3 THROUGH 10/3 UNDERGROUND FEEDER 14/2 & 12/3	9/16"	BUCKET	5000
196	ARMORED CABLE 8/3	13/16"	100	5000
197	METAL CLAD CABLE 8/3 NONMETALLIC SHEATHED 18/3 THROUGH 6/3 UNDERGROUND FEEDER 10/3	13/16"	500	5000

FEATURES

- Pointed legs drive straight and limit splitting of wood
- Recessed heads drive fast and protect cable insulation
- Sharp tips for easier starting
- Strong, resilient steel construction

APPLICATION

- Secures Romex® Brand nonmetallic sheathed cable, armored cable, metal clad cable, and feeder cable

MATERIAL

- Steel

SERVICE ENTRANCE

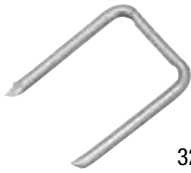

32-1

PART #	CABLE RANGE	SIZE	INNER QTY	MASTER QTY
32-1	#6/3 SEU	3/4" x 1-5/16"	100	1000
34-1	#2/3 SEU	1" x 1"	100	1000
36-1	#4/0 SEU	1-5/8" x 2-1/8"	100	500
186	#4/3 SEU THROUGH #2/3 SER	1-11/16"	100	1000
198	2/0 SEU THROUGH 2/0 SER	1-11/32"	100	1000

FEATURES

- Pointed offset to drive in straight
- Strong, resilient steel construction

APPLICATION

- Secures Romex® Brand nonmetallic sheathed cable, armored cable, BX, and flexible conduit to wood or masonry

MATERIAL

- Steel

INSULATED



183I

PART #	CABLE RANGE	SIZE	INNER QTY	MASTER QTY
183I	ARMORED CABLE 14/2 & 14/3	1/2"	100	5000
184I	METAL CLAD CABLE 14/2 & 14/3	1/2"	500	5000
185I	NONMETALLIC SHEATHED 14/2 THROUGH 10/3 UNDERGROUND FEEDER 14/2 & 14/3	1/2"	BUCKET	2500

FEATURES

- Plastic insulator protects cable
- Strong, resilient steel construction

APPLICATION

- Secures Romex® Brand nonmetallic sheathed cable, armored cable, metal clad cable, and feeder cable

MATERIAL

- Steel nail with plastic insulator

NAIL PLATES

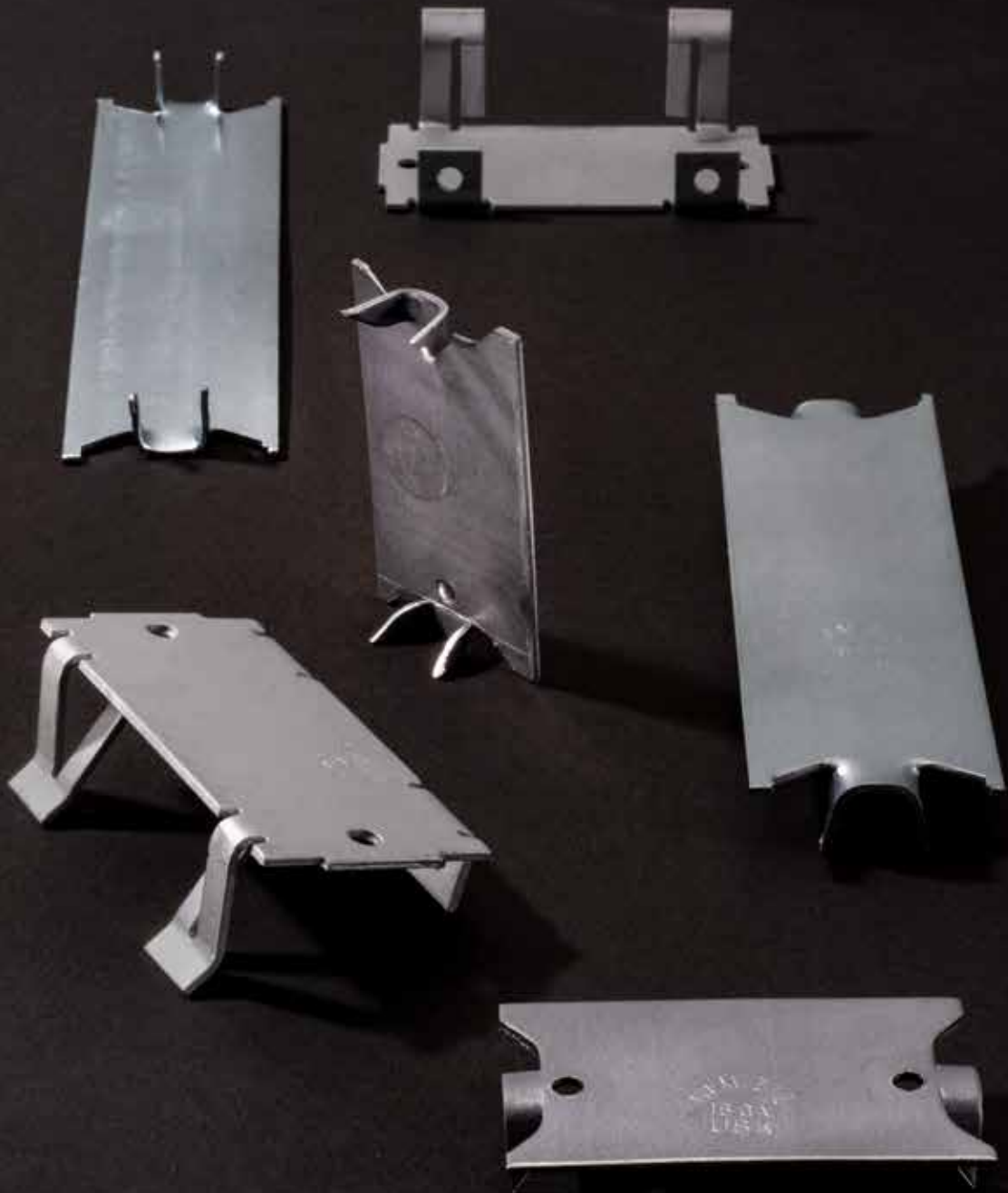

PRESS-ON NAIL PLATE



304B2TZ

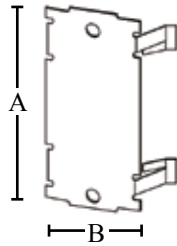

PART #	A	B	C	D	BOX QTY.
304B2TZ	3.13"	1.50"	.547"	1.02"	100

FEATURES

- Easy no-tool installation
- For metal or wood studs
- Holes provided on clip legs to screw into stud for additional support

APPLICATION

- Press-on nail plates protect electrical and mechanical gear routed through studs

MATERIAL/FINISH

- Steel/GEOSEAL™

CERTIFICATIONS

- UL Standard: UL 2239



NAIL PLATES



SP-3



SP-6



188



43-50

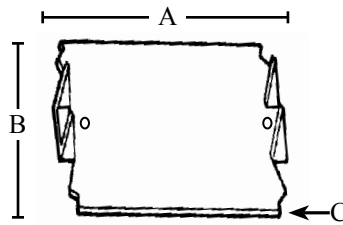

FEATURES

- 16-gauge thickness
- Hammer-on installation
- Spiked ends for wood studs
- Clip tabs for metal studs

APPLICATION

- Use to protect wire and cable from nails or screws in wood stud construction
- Mounts on outside of the stud face

MATERIAL/FINISH

- Steel



PART #	STUD MATERIAL	ATTACHMENT	PLATE SIZE	A	B	C	BOX QTY.
SP-3	WOOD	SPIKE	1-1/2" x 2-1/2"	2.50"	1.50"	.0625"	200
SP-6	WOOD	SPIKE	1-1/2" x 6" x 1/16"	5"	1.50"	.0625"	100
187A	WOOD	SPIKE	3-1/2" x 6" x 1/16"	6"	3.50"	.0625"	50
188	WOOD	SPIKE	1-1/2" x 5" x 1/16"	6"	1.50"	.0625"	100
189B	WOOD	SPIKE	1-1/2" x 2-1/2" x 1/16"	2.50"	1.50"	.0625"	50
43-50	WOOD	SPIKE	1-1/2" x 2-1/2"	2.50"	1.50"	.0625"	250
43-100	WOOD	SPIKE	1-1/2" x 2-1/2"	2.50"	1.50"	.0625"	100
43-5P	WOOD	SPIKE	1-1/2" x 2-1/2" (PAIL PACK)	2.50"	1.50"	.0625"	500

DATACOM/ LOW VOLTAGE

**Wire management systems that
support data and low voltage cables
to the structure**

CABLE SUPPORT SYSTEMS

LOW VOLTAGE CABLE MANAGEMENT

CLIPS

J-HOOKS

WALL MOUNT WITH MOUNTING HOLES



CAT12TZ

CAT21TZ

JHK-32SS

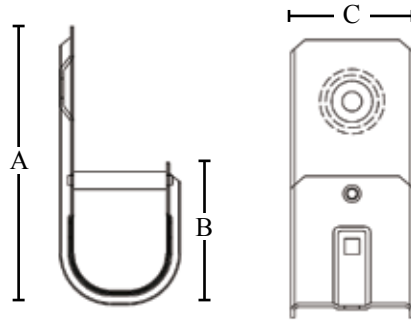

FEATURES

- J-Hooks eliminate the problem of point loads that can cause band width damage to sensitive cables such as fiber optic, CAT 5E, 6, 7 or many others
- Continuous wide base radius design supports the natural bends and curves of cable
- Built-in cable retainer bar
- .264" diameter mounting hole

APPLICATION

- Wall mount J-Hook cable supports can be attached to a wide variety of wall surfaces
- Southwire J-Hooks are an inexpensive alternative to cable trays
- J-Hooks provide support to sensitive voice and data cables without causing stress

MATERIAL/FINISH

- Steel/Galvanized or Stainless steel

CERTIFICATIONS

- * cULus Listed
- **UL listed



PART #	HOOK DIAMETER	MATERIAL	STATIC LOAD (LBS.)	CAT 5E CABLE CAPACITY	A	B	C	BOX QTY.
CAT12TZ*	3/4"	GALVANIZED STEEL	60	16	3.23"	1.65"	.866"	100
CAT21TZ*	1-5/16"		60	50	3.62"	1.79"	1.64"	40
CAT32TZ*	2"		60	90	4.37"	2.50"	1.64"	50
CAT64TZ*	4"		60	330	4.48"	2.50"	1.91"	25
JHK-84**	6"		60	450	6.93"	3.75"	2.02"	25
JHK-12SS**	3/4"	STAINLESS STEEL	60	20	3.23"	1.65"	.866"	50
JHK-21SS**	1-5/16"		60	40	3.62"	1.79"	1.64"	50
JHK-32SS**	2"		60	80	4.37"	2.50"	1.64"	50
JHK-64SS**	4"		60	300	4.48"	2.50"	1.91"	25

Load Limits apply to fastener only. Anchor must be evaluated separately

*cULus Listed, **UL listed, JHK-84- no UL

HANGING AND SUPPORT

J-HOOKS WITH SPRING

STEEL BEAM CLAMP



CAT21BCTZ

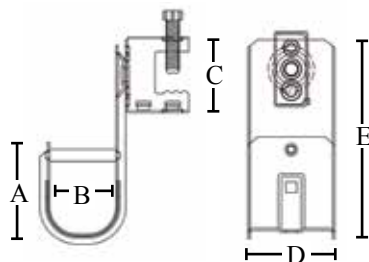

FEATURES

- Available in multiple sizes
- Alternative cable management solution to complex cable trays
- J-Hooks are designed with round edges to provide proper bend radius
- Beam clamp screw-on attachment allows for easy repositioning of the J-Hook

APPLICATION

- J-Hooks with screw-on beam clamp feature allows the J-Hook to easily attach to beam flanges
- J-Hooks provide support for data cables: fiber optic, inner-duct and low voltage

MATERIAL/FINISH

- Clamp: Spring Steel/ GEOSEAL™
- J-Hook: Steel/Galvanized

CERTIFICATIONS

- UL Standard: UL 2239



PART #	HOOK DIAMETER	A	B	C	D	E	BOX QTY.
CAT12BCTZ	3/4"	1.65"	.748"	1.42"	.866"	3.23"	40
CAT21BCTZ	1-5/16"	1.79"	1.24"	1.42"	1.64"	3.62"	50
CAT32BCTZ	2"	2.50"	1.99"	1.42"	1.64"	4.37"	50



HANGING AND SUPPORT

J-HOOKS WITH BEAM CLAMP



JHK-21-BC

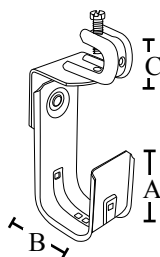

FEATURES

- J-Hooks eliminate the problem of point loads that can cause band width damage to sensitive cables such as fiber optic, CAT 5E, 6, 7 or many others
- Continuous wide base radius design supports the natural bends and curves of cable
- Built-in cable retainer bar

APPLICATION

- J-Hook cable support with stamped steel beam clamp can be attached to a wide variety of flange edges or beams
- Southwire J-Hooks are an inexpensive alternative to cable trays
- J-Hooks provide support to sensitive voice and data cables without causing stress

MATERIAL/FINISH

- Steel/Zinc plated

PART #	HOOK DIAMETER	A	B	C	BOX QTY.
JHK-21-BC	1-5/16"	3.62"	1.63"	1.64"	50
JHK-32-BC	2"	4.37"	1.63"	1.64"	50
JHK-64-BC	4"	4.48"	1.63"	1.91"	25

J-HOOKS, BEAM/EDGE MOUNT

HAMMER-ON CLIP



JHK-12-HO



CAT3224TZ

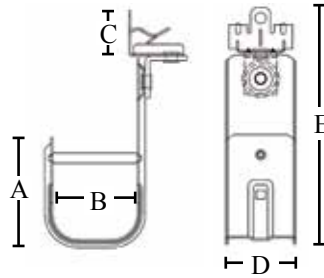

FEATURES

- J-Hooks eliminate the problem of point loads that can cause band width damage to sensitive cables such as fiber optic, CAT 5E, 6, 7 or many others
- Continuous wide base radius design supports the natural bends and curves of cable
- Built-in cable retainer bar
- 360° rotation of J-Hook

APPLICATION

- J-Hook cable supports with hammer-on beam edge clip can be attached to a wide variety of flange edges or beams
- Southwire J-Hooks are an inexpensive alternative to cable trays
- J-Hooks provide support to sensitive voice and data cables without causing stress

MATERIAL/FINISH

- Clamp: Spring Steel/ GEOSEAL™
- J-Hook: Steel/Galvanized

CERTIFICATIONS

- UL Standard: UL 2239



PART #	BEAM FLANGE THICKNESS	HOOK DIAMETER	CAT5E CABLE CAPACITY	A	B	C	D	E	BOX QTY.
JHK-12-HO**	1/8" TO 1/4"	3/4"	20	.748"	1.65"	1.06"	.866"	4.29"	50
JHK-12-H0516**	5/16" TO 1/2"	3/4"	20	.748"	1.65"	1.34"	.866"	4.57"	50
JHK-12-H0916**	9/16" TO 3/4"	3/4"	20	.748"	1.65"	1.63"	.866"	4.86"	50
JHK-21-HO**	1/8" TO 1/4"	1-5/16"	40	1.24"	1.79"	1.06"	1.64"	4.68"	50
JHK-21-H0516**	5/16" TO 1/2"	1-5/16"	40	1.24"	1.79"	1.34"	1.64"	4.96"	50
JHK-21-H0916**	9/16" TO 3/4"	1-5/16"	40	1.24"	1.79"	1.63"	1.64"	5.25"	50
CAT3224TZ*	1/8" TO 1/4"	2"	80	1.99"	2.5"	1.06"	1.64"	5.43"	50
JHK-32-H0516**	5/16" TO 1/2"	2"	80	1.99"	2.5"	1.34"	1.64"	5.71"	50
JHK-32-H0916**	9/16" TO 3/4"	2"	80	1.99"	2.5"	1.63"	1.64"	6"	50
JHK-64-HO**	1/8" TO 1/4"	4"	300	4.0"	4.69"	1.06"	1.91"	7.99"	25
JHK-64-H0516**	5/16" TO 1/2"	4"	300	4.0"	4.69"	1.34"	1.91"	8.27"	25
JHK-64-H0916**	9/16" TO 3/4"	4"	300	4.0"	4.69"	1.63"	1.91"	8.56"	25

*cULus Listed, **UL listed

J-HOOKS WITH CLIP



JHK-21-BW2

CAT124Z34TZ

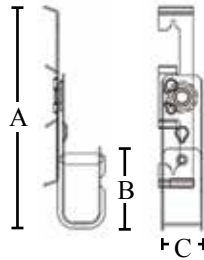

PART #	HOOK DIAMETER	ROD SIZE	A	B	C	BOX QTY.
CAT124Z34TZ*	3/4"	1/4"	3.23"	1.65"	.866"	40
CAT126Z34TZ*	3/4"	3/8"	4.171"	1.65"	.866"	50
JHK-21-BW2**	1-5/16"	1/4"	4.561"	1.79"	1.64"	50
JHK-21-BW6**	1-5/16"	3/8"	4.561"	1.79"	1.64"	50
CAT324Z34TZ*	2"	1/4"	5.311"	2.50"	1.64"	50
CAT326Z34TZ*	2"	3/8"	5.311"	2.50"	1.64"	50
JHK-64-BW2**	4"	1/4"	5.421"	2.50"	1.91"	25

*cULus Listed | **UL listed

FEATURES

- Easy no-tool installation
- Available in multiple sizes
- J-Hooks are designed with round edges to provide proper bend radius
- Rod/wire clip feature allows for easy repositioning of J-Hook

APPLICATION

- J-Hook with clip feature allows the J-Hook to easily attach to beams, threaded rods, or wires
- J-Hooks provide support for data cables: fiber optic, inner-duct, and low voltage

MATERIAL/FINISH

- Clip: Spring Steel/ GEOSEAL™
- J-Hook: Steel/Galvanized

CERTIFICATIONS

- UL Standard: UL 2239



J-HOOKS, MAGNETIC MOUNT



JHK-12MAG



FEATURES

- J-Hooks eliminate the problem of point loads that can cause band width damage to sensitive cables such as fiber optic, CAT 5E, 6, 7 or many others
- Continuous wide base radius design supports the natural bends and curves of cable
- Built-in cable retainer bar

APPLICATION

- Magnetic wall mount J-Hook cable supports can be attached to a wide variety of metal wall surfaces
- Southwire J-Hooks are an inexpensive alternative to cable trays
- J-Hooks provide support to sensitive voice and data cables without causing stress

MATERIAL/FINISH

- Steel/Zinc plated

PART #	MATERIAL	HOOK SIZE	CAT5E CABLE CAPACITY	PULL-OUT STRENGTH	BOX QTY.
JHK-12MAG	ZINC PLATED STEEL	3/4"	20	90 LBS.	50
JHK-21MAG		1-5/16"	40	90 LBS.	50
JHK-32MAG		2"	80	90 LBS.	50
JHK-64MAG		4"	300	90 LBS.	25
JHK-84MAG		6"	450	90 LBS.	25

J-HOOKS OVERHEAD MOUNT



JHK-12-AB

JHK-21-ABSS



PART #	MATERIAL	HOOK SIZE	CAT5E CABLE CAPACITY	BOX QTY.
JHK-12-AB	ZINC PLATED STEEL	3/4"	20	50
JHK-21-AB		1-5/16"	40	50
JHK-32-AB		2"	80	50
JHK-64-AB		4"	300	25
JHK-12-ABSS	316 STAINLESS STEEL	3/4"	20	50
JHK-21-ABSS		1-5/16"	40	50
JHK-32-ABSS		2"	80	50
JHK-64-ABSS		4"	300	25

FEATURES

- J-Hooks eliminate the problem of point loads that can cause band width damage to sensitive cables such as fiber optic, CAT 5E, 6, 7 or many others
- Continuous wide base radius design supports the natural bends and curves of cable
- Built-in cable retainer bar
- .26" diameter mounting hole

APPLICATION

- Overhead mount J-Hook cable supports can be attached to a wide variety of overhead surfaces or combined with other Southwire spring steel hardware
- Southwire J-Hooks are an inexpensive alternative to cable trays
- J-Hooks provide support to sensitive voice and data cables without causing stress

MATERIAL/FINISH

- Steel/Zinc plated or 316 Stainless steel

CERTIFICATIONS

- UL Listed (for Zinc plated Steel)

MAGNETIC OVERHEAD MOUNT J-HOOKS



JHK-12ABMAG



FEATURES

- J-Hooks eliminate the problem of point loads that can cause band width damage to sensitive cables such as fiber optic, CAT 5E, 6, 7 or many others
- Continuous wide base radius design supports the natural bends and curves of cable
- Built-in cable retainer bar

APPLICATION

- Magnetic overhead mount J-Hook cable supports can be attached to a wide variety of metal overhead surfaces
- Southwire J-Hooks are an inexpensive alternative to cable trays
- J-Hooks provide support to sensitive voice and data cables without causing stress

MATERIAL/FINISH

- Steel/Zinc plated

PART #	MATERIAL	HOOK SIZE	CAT5E CABLE CAPACITY	PULL-OUT STRENGTH	BOX QTY.
JHK-12ABMAG	ZINC PLATED STEEL	3/4"	20	90 LBS.	50
JHK-21ABMAG		1-5/16"	40	90 LBS.	50
JHK-32ABMAG		2"	80	90 LBS.	50
JHK-64ABMAG		4"	300	90 LBS.	25

HANGING AND SUPPORT

FLOOR SUPPORT J-HOOK



CAT21CD1BTZ

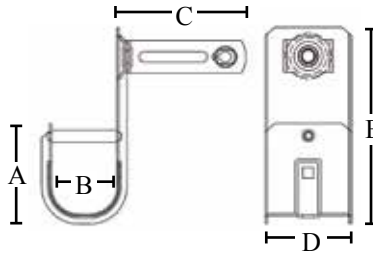

PART #	A	B	C	D	E	BOX QTY.
CAT21CD1BTZ	1.79"	1.24"	2.26"	1.64"	3.62"	50

FEATURES

- J-Hooks are designed with round edges to provide proper bend radius
- 1-5/16" diameter J-Hook

APPLICATION

- J-Hooks provide support for data cables: fiber optic, inner duct and low voltage
- Pipe anchor clamp feature allows the J-Hook to easily attach to floor supports

MATERIAL/FINISH

- Steel/Galvanized

CERTIFICATIONS

- UL Standard: UL 2239



MULTI-RUN OVERHEAD MOUNT J-HOOKS



JHT-212



JHT-214



JHT-216

FEATURES

- J-Hooks eliminate the problem of point loads that can cause band width damage to sensitive cables such as fiber optic, CAT5E, 6, 7 or many others
- Continuous wide base radius design supports the natural bends and curves of cable
- Built-in cable retainer bar
- .26" diameter mounting hole

APPLICATION

- Overhead mount multi-run J-Hook cable supports can be attached to a wide variety of overhead surfaces.
- Southwire J-Hooks are an inexpensive alternative to cable trays
- J-Hooks provide support to sensitive voice and data cables without causing stress

MATERIAL/FINISH

- Steel/Zinc plated

PART #	NUMBER OF HOOKS	HOOK DIAMETER	CAT5E CABLE CAPACITY	BOX QTY.
JHT-212	2	1-5/16"	40 EACH HOOK	25
JHT-214	4	1-5/16"	40 EACH HOOK	25
JHT-216	6	1-5/16"	40 EACH HOOK	25
JHT-322	2	2"	80 EACH HOOK	25
JHT-324	4	2"	80 EACH HOOK	25
JHT-326	6	2"	80 EACH HOOK	25
JHT-642	2	4"	300 EACH HOOK	10
JHT-644	4	4"	300 EACH HOOK	10
JHT-646	6	4"	300 EACH HOOK	10

G-HOOKS, WALL MOUNT



CAT150-WM



FEATURES

- Provides a smooth surface for cables
- .28" diameter mounting hole

APPLICATION

- Wall mount G-Hook cable supports can be attached to a wide variety of wall surfaces and are a cost effective alternative to J-Hooks
- G-Hooks provide support to sensitive voice and data cables without causing stress

MATERIAL/FINISH

- Steel/Zinc plated

CERTIFICATIONS

- cULus Listed

PART #	MATERIAL	LOOP SIZE	CAT5E CABLE CAPACITY	BOX QTY.
CAT150-WM	ZINC PLATED STEEL	1-1/2"	14	50
CAT200-WM		2"	24	50
CAT400-WM		4"	48	25

MAGNETIC MOUNT



CAT150-WMAG

FEATURES

- Provides a smooth surface for cables

APPLICATION

- Magnetic mount G-Hook cable supports can be attached to a wide variety of metal wall surfaces and are a cost effective alternative to J-Hooks
- G-Hooks provide support to sensitive voice and data cables without causing stress

MATERIAL/FINISH

- Steel/Zinc plated

PART #	MATERIAL	LOOP SIZE	CAT5E CABLE CAPACITY	PULL-OUT STRENGTH	BOX QTY.
CAT150-WMAG	ZINC PLATED STEEL	1-1/2"	14	90 LBS.	50
CAT200-WMAG		2"	24	90 LBS.	50
CAT400-WMAG		4"	48	90 LBS.	25

G-HOOKS, OVERHEAD MOUNT



CAT150-AB



PART #	MATERIAL	LOOP SIZE	CAT5E CABLE CAPACITY	BOX QTY.
CAT150-AB	ZINC PLATED STEEL	1-1/2"	14	50
CAT200-AB		2"	24	50
CAT400-AB		4"	48	25

FEATURES

- Provides a smooth surface for cables
- .28" diameter mounting hole

APPLICATION

- Overhead mount G-Hook cable supports can be attached to a wide variety of overhead surfaces and are a cost effective alternative to J-Hooks
- G-Hooks provide support to sensitive voice and data cables without causing stress

MATERIAL/FINISH

- Steel/Zinc plated

CERTIFICATIONS

- cULus

MAGNETIC MOUNT



CAT150-MAG

PART #	MATERIAL	LOOP SIZE	CAT5E CABLE CAPACITY	PULL-OUT STRENGTH	BOX QTY.
CAT150-MAG	ZINC PLATED STEEL	1-1/2"	4	90 LBS.	50
CAT200-MAG		2"	24	90 LBS.	50
CAT400-WMAG		4"	48	90 LBS.	25

FEATURES

- Provides a smooth surface for cables

APPLICATION

- Overhead magnetic mount G-Hook cable supports can be attached to a wide variety of metal overhead surfaces and are a cost effective alternative to J-Hooks
- G-Hooks provide support to sensitive voice and data cables without causing stress

MATERIAL/FINISH

- Steel/Zinc plated

1/4"-20 THREADED STUD



CAT150



PART #	MATERIAL	LOOP SIZE	CAT5E CABLE CAPACITY	BOX QTY.
CAT150	ZINC PLATED STEEL	1-1/2"	14	50
CAT200		2"	24	50
CAT400		4"	48	25

FEATURES

- Provides a smooth surface for cables
- 1" approximate stud length

APPLICATION

- Overhead 1/4"-20 stud mount G-Hook cable supports can be attached to a wide variety of overhead surfaces and are a cost effective alternative to J-Hooks
- G-Hooks provide support to sensitive voice and data cables without causing stress

MATERIAL/FINISH

- Steel/Zinc plated

LOW VOLTAGE CABLE MANAGEMENT



WOOD THREADED BRIDLE RINGS



4BRT32WSTZ

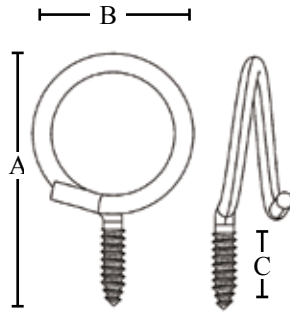

FEATURES

- Available in multiple ring diameters
- Wood screw threads allow rings to be screwed into wood surfaces

APPLICATION

- Threaded bridle rings are used to support communication cables and other low voltage wires
- Southwire bridle rings allow a quick and inexpensive way to support non data sensitive wires and cables from structural members

MATERIAL/FINISH

- Steel/Galvanized

CERTIFICATIONS

- UL Standard: UL 2239



PART #	DIAMETER	THREAD	CAT5E CABLE CAPACITY	A	B	C	BOX QTY.
BR-100-WS*	1"	#14	20	2.72"	1.65"	.512"	100
4BRT20WSTZ**	1-1/4"	#14	30	2.60"	1.65"	.512"	100
BR-150-WS*	1-1/2"	#14	42	3.22"	1.91"	.512"	100
4BRT32WSTZ**	2"	#14	73	3.70"	2.42"	.571"	100

*UL listed | **cULus listed



MACHINE THREADED BRIDLE RINGS



4BRT20TZ



BR-501024



BR-125-SS

FEATURES

- Available in multiple ring diameters
- Machine screw threads allow rings to be screwed into other fasteners and clamps

APPLICATION

- Threaded bridle rings are used to support communication cables and other low voltage wires
- Southwire bridle rings allow a quick and inexpensive way to support non data sensitive wires and cables from structural members

MATERIAL/FINISH

- Steel/Galvanized or 316 Stainless steel

CERTIFICATIONS

- UL Standard: UL 2239

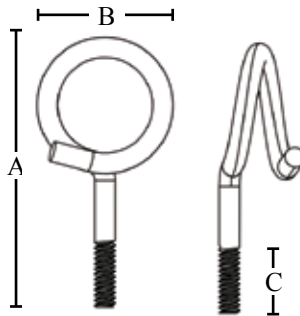

PART #	MATERIAL	DIAMETER	THREAD SIZE	CAT5E CABLE CAPACITY	A	B	C	BOX QTY.
BR-501024*	ZINC PLATED STEEL	1/2"	#10 - 24	5	2.11"	1.06	.512"	100
2BRT12TZ**		3/4"	#10 - 24	10	1.97"	1.10"	.512"	100
BR-1001024*		1"	#10 - 24	20	2.72"	1.65"	.512"	100
2BRT20TZ**		1-1/4"	#10 - 24	30	2.62"	1.57"	.512"	100
BR-1501024*		1-1/2"	#10 - 24	42	3.22"	1.91"	.512"	100
2BRT32TZ**		2"	#10 - 24	73	3.31"	2.46"	.571"	100
4BRT20TZ**		1-1/4"	1/4" - 20	30	2.74"	1.65"	.512"	100
BR-150*		1-1/2"	1/4" - 20	42	3.22"	1.91"	.512"	100
4BRT32TZ**		2"	1/4" - 20	73	2.56"	3.57"	.571"	100
4BRT64TZ**		4"	1/4" - 20	250	6.51"	4.45"	.689"	50
BR-125-SS*	316 STAINLESS STEEL	1-1/4"	1/4" - 20	30	2.60"	1.65"	.512"	100
BR-150-SS*		1-1/2"	1/4" - 20	42	3.22"	1.91"	.512"	100
BR-200-SS*		2"	1/4" - 20	73	2.56"	3.57"	.571"	100
BR-400-SS*		4"	1/4" - 20	250	6.51"	4.45"	.689"	50

*UL listed | **cULus listed

HANGING AND SUPPORT

METAL THREADED RINGS

WITH NONMETALLIC SADDLE



BR-150-WH



FEATURES

- Nonmetallic saddle support provides additional support under cable

APPLICATION

- Threaded bridle rings are used to support communication cables and other low voltage wires
- Southwire bridle rings allow a quick and inexpensive way to support non data sensitive wires and cables from structural members

MATERIAL/FINISH

- Steel/Zinc plated
- Plastic saddle

CERTIFICATIONS

- UL Listed (BR-200-WH and BR-400-WH)

PART #	MATERIAL	LOOP SIZE	LEG THREAD	CAT5E CABLE CAPACITY	BOX QTY.
BR-150-WH	ZINC PLATED STEEL	1-1/2"	1/4" - 20	42	100
BR-200-WH		2"	1/4" - 20	73	100
BR-400-WH		4"	1/4" - 20	250	25

WOOD THREADED RINGS

WITH NONMETALLIC SADDLE



BR-150-WHWS



FEATURES

- Nonmetallic saddle support provides additional support under cable

APPLICATION

- Threaded bridle rings are used to support communication cables and other low voltage wires
- Southwire bridle rings allow a quick and inexpensive way to support non data sensitive wires /and cables from structural members

MATERIAL/FINISH

- Steel/Zinc plated
- Plastic saddle

PART #	MATERIAL	LOOP SIZE	CAT5E CABLE CAPACITY	BOX QTY.
BR-150-WHWS	ZINC PLATED STEEL	1-1/2"	42	100
BR-200-WHWS		2"	73	100

SNAP-ON DATA SADDLE ONLY

FOR BRIDLE RINGS, NONMETALLIC



BRS150

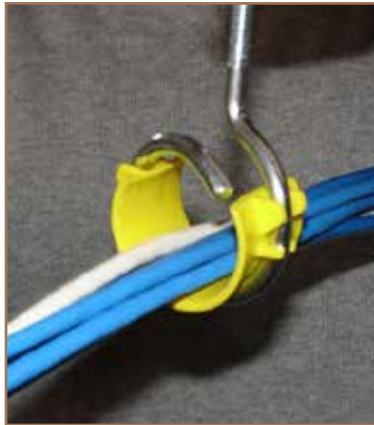

FEATURES

- Snap-on design for quick installation
- Plenum Rated

APPLICATION

- Nonmetallic saddle support work with Southwire 1-1/2" and 2" bridle rings and provides additional support under cable

MATERIAL/FINISH

- Plastic/Yellow

CERTIFICATIONS

- UL Listed



PART #	MATERIAL	FITS RING SIZE	BOX QTY.
BRS150	PLENUM RATED SADDLE	1-1/2"	50
BRS200		2"	50

BRIDLE RINGS

SCREW MOUNT LOOP HOLE



BR-150NP



PART #	MATERIAL	LOOP SIZE	CAT5E CABLE CAPACITY	BOX QTY.
BR-150NP	ZINC PLATED STEEL	1-1/2"	42	100
BR-200NP		2"	73	100
BR-400NP		4"	250	50

FEATURES

- .26" diameter screw opening

APPLICATION

- Screw-mount loop hole mount bridle rings are used to support communication cables and other low voltage wires on overhead surface mount applications
- Southwire bridle rings allow a quick and inexpensive way to support non data sensitive wires and cables from structural members

MATERIAL/FINISH

- Steel/Zinc plated

CERTIFICATIONS

- UL Listed

HANGING AND SUPPORT

BRIDLE RINGS, QUICK-SHOT FOR STEEL OR CONCRETE

WITH NONMETALLIC DATA SADDLE



BR-150-SSCWH



BR-150-SSC

FEATURES

- Compatible with all powder and gas guns
- Pre-assembled ready to shoot
- Nonmetallic saddle support provides additional support under cable

APPLICATION

- "Quick-shot" mount bridle rings are used to support communication cables and other low voltage wires on overhead surface mount applications
- Southwire bridle rings allow a quick and inexpensive way to support non data sensitive wires and cables from structural members

MATERIAL/FINISH

- Steel/Zinc plated

PART #	MATERIAL	LOOP SIZE	CAT5E CABLE CAPACITY	BOX QTY.
BR-150-SSCWH	ZINC PLATED STEEL	1-1/2"	42	100
BR-150-SSC		1 1/2"	42	100
BR-200-SSC		2"	73	100
BR-200-SSCWH		2"	73	100
BR-400-SSC		4"	250	50

BRIDLE RINGS, HOLLOW-WALL MOUNT

WITH EXPANSION TOGGLE



BR-150-TW



FEATURES

- 3-1/2" long leg
- Pop-out toggle-wing to secure in place behind wall surface

APPLICATION

- Hollow wall mount bridle rings are used to support communication cables and other low voltage wires
- Southwire bridle rings allow a quick and inexpensive way to support non data sensitive wires and cables from structural members

MATERIAL/FINISH

- Steel/Zinc plated

CERTIFICATIONS

- UL Listed

PART #	MATERIAL	LOOP SIZE	CAT5E CABLE CAPACITY	BOX QTY.
BR-150-TW	ZINC PLATED STEEL	1-1/2"	42	50
BR-200-TW		2"	73	50
BR-400-TW		4"	250	25

HANGING AND SUPPORT

BRIDLE RINGS

MAGNETIC MOUNT



BRM150-HD



BRM75WH

FEATURES

- Easy to mount

APPLICATION

- Magnetic mount bridle rings are used to support communication cables and other low voltage wires on metal surface mount applications
- Southwire bridle rings allow a quick and inexpensive way to support non data sensitive wires and cables from structural members

MATERIAL/FINISH

- Steel/Zinc plated

PART #	MATERIAL/COLOR	LOOP SIZE	CAT5E CABLE CAPACITY	PULL-OUT STRENGTH	BOX QTY.
BRM75BK	STEEL, PAINTED BLACK	3/4"	10	15 LBS.	100
BRM75WH	STEEL, PAINTED WHITE	3/4"	10	15 LBS.	100
BRM100BK	STEEL, PAINTED BLACK	1"	20	15 LBS.	100
BRM100WH	STEEL, PAINTED WHITE	1"	20	15 LBS.	100
BRM125BK	STEEL, PAINTED BLACK	1-1/4"	30	15 LBS.	100
BRM125WH	STEEL, PAINTED WHITE	1-1/4"	30	15 LBS.	100
BRM150-HD	ZINC PLATED STEEL	1-1/2"	42	90 LBS.	50
BRM200-HD		2"	73	90 LBS.	50
BRM400-HD		4"	250	90 LBS.	50

DISTRIBUTION RINGS

SURFACE MOUNT, METALLIC



DST-200

FEATURES

- Distribution rings have a smooth surface that prevents cables from being damaged
- .22" diameter mounting holes

APPLICATION

- Distribution rings are used when support for multiple vertical or horizontal cable runs is required on walls or ceilings

MATERIAL/FINISH

- Aluminum
- Steel/Zinc plated

PART #	MATERIAL	CABLE I.D.	CAT5E CABLE CAPACITY	BOX QTY.
DST-200	ALUMINUM	2"	75	50
DST-300		3"	150	50
DST-500		5"	250	25
DST-800	ZINC PLATED STEEL	8"	425	25
DST-1200		12"	550	25

DISTRIBUTION RINGS, SURFACE MOUNT, METALLIC



17AB

PART #	MATERIAL/COLOR	SUPPORT LOOP	BOX QTY.
17AB	STEEL, PAINTED BLACK	7/8" X 1-1/2"	100
17BB		1" X 1-7/8"	100
17CB		1-3/8" X 2-3/4"	100

FEATURES

- Distribution rings have a smooth non-conductive surface that prevents cables from being damaged
- .175" diameter mounting holes

APPLICATION

- Support loop distribution rings are used when support for small cable runs is required on walls or communication boards and racks.
- Commonly used on communication back boards and other flat surfaces to sort and structure wires.

MATERIAL/FINISH

- Steel/Black paint

WIREBRACKET™ CABLE SUPPORT DEVICE NONMETALLIC



WB200



PART #	MATERIAL	TRADE SIZE	BOX QTY.
WB200	NYLON, BLACK	2"	25

FEATURES

- Cable tie installation holes in each corner of ring to separate groups of cables
- Smooth interior surface
- Mounting holes accept tap cons, 1/4" bolts for beam clamps and light Hilti loads (1.5" nail with fender washer)
- MC does not require cable ties when 10 or less cables in ring

APPLICATION

- Dual purpose line voltage and low voltage cable support device for residential or commercial use

MATERIAL/FINISH

- Nylon/Black

CERTIFICATIONS

- UL Listed

DISTRIBUTION RINGS

SURFACE MOUNT, NONMETALLIC



DST-200-P

PART #	MATERIAL	CABLE I.D.	CAT5E CABLE CAPACITY	BOX QTY.
DST-200-P	GRAY PLASTIC	2"	75	50
DST-300-P		3"	150	50
DST-500-P		5"	250	25

FEATURES

- Distribution rings have a smooth surface that prevents cables from being damaged
- .21" diameter mounting holes

APPLICATION

- Distribution rings are used when support for multiple vertical or horizontal cable runs is required on walls or ceilings

MATERIAL/FINISH

- Plastic/Gray

OPEN DISTRIBUTION RINGS

SURFACE MOUNT, METALLIC



ODR-250

PART #	MATERIAL	DIMENSIONS (H X W)	BOX QTY.
ODR-250	DIE-CAST ALUMINUM	2" X 2"	50
ODR-350		1-1/2" X 3"	50
ODR-375		3" X 3"	50

FEATURES

- Distribution rings have a smooth surface that prevents cable damage
- .22" diameter mounting holes

APPLICATION

- Drop in/open style distribution rings are used when support is needed for cables that must remain accessible

MATERIAL/FINISH

- Aluminum/Die-Cast

BACKBOARD SPOOLS

NONMETALLIC ABS



WDS

PART #	MOUNTING	DIMENSIONS	COLOR	BOX QTY.
WDS	MOUNTING HOLE ONLY	2.91" TALL	IVORY	100
WDSWS	MOLDED IN WOOD SCREW	2.91" TALL	GRAY	100
WDSMS	MOLDED IN WOOD SCREW ***	2.91" TALL	BLACK	100

FEATURES

- Smooth wire contact surface
- Sold with or without mounting screw

APPLICATION

- Wire distribution spools are used to neatly organize internal pairs or wires as they are being terminated on communication backboards and racks that are wood, steel or concrete

MATERIAL/FINISH

- Plastic/White

DRIVE RINGS, NAIL-ON MOUNT

GALVANIZED STEEL



DRV-1/2

PART #	LOOP SIZE	CAT5E CABLE CAPACITY	BOX QTY.
DRV-1/2	1/2"	5	50
DRV-5/8	5/8"	10	25
DRV-7/8	7/8"	30	25
DRV-1-1/4	1-1/4"	65	25
DRV-1-1/2	1-1/2"	90	25

FEATURES

- Smooth wire contact surface
- .21" diameter mounting holes

APPLICATION

- Drive rings are used to support communication cables and other low voltage wires
- Quick nail-on drive rings with looped harness saves time and provides a very economical support in wet or dry locations
- Drive rings may also be used on wood surfaces or with beam clamps that accept drive pins

MATERIAL/FINISH

- Steel/Galvanized

DRIVE RINGS, WITH SCREW MOUNT LOOP HOLE

GALVANIZED STEEL



DRS-1/2

PART #	SIZE	CAT5E CABLE CAPACITY	BOX QTY.
DRS-1/2	1/2"	5	50
DRS-5/8	5/8"	10	25
DRS-7/8	7/8"	30	25
DRS-1-1/4	1-1/4"	65	25
DRS-1-1/2	1-1/2"	90	25

FEATURES

- Smooth wire contact surface
- Screw-on drive rings work with most common drywall screws and threaded fasteners

APPLICATION

- Screw-on drive rings are used to support and secure wires and cables in tight spaces where hammer-on drive rings will not work

MATERIAL/FINISH

- Steel/Galvanized

CLIPS

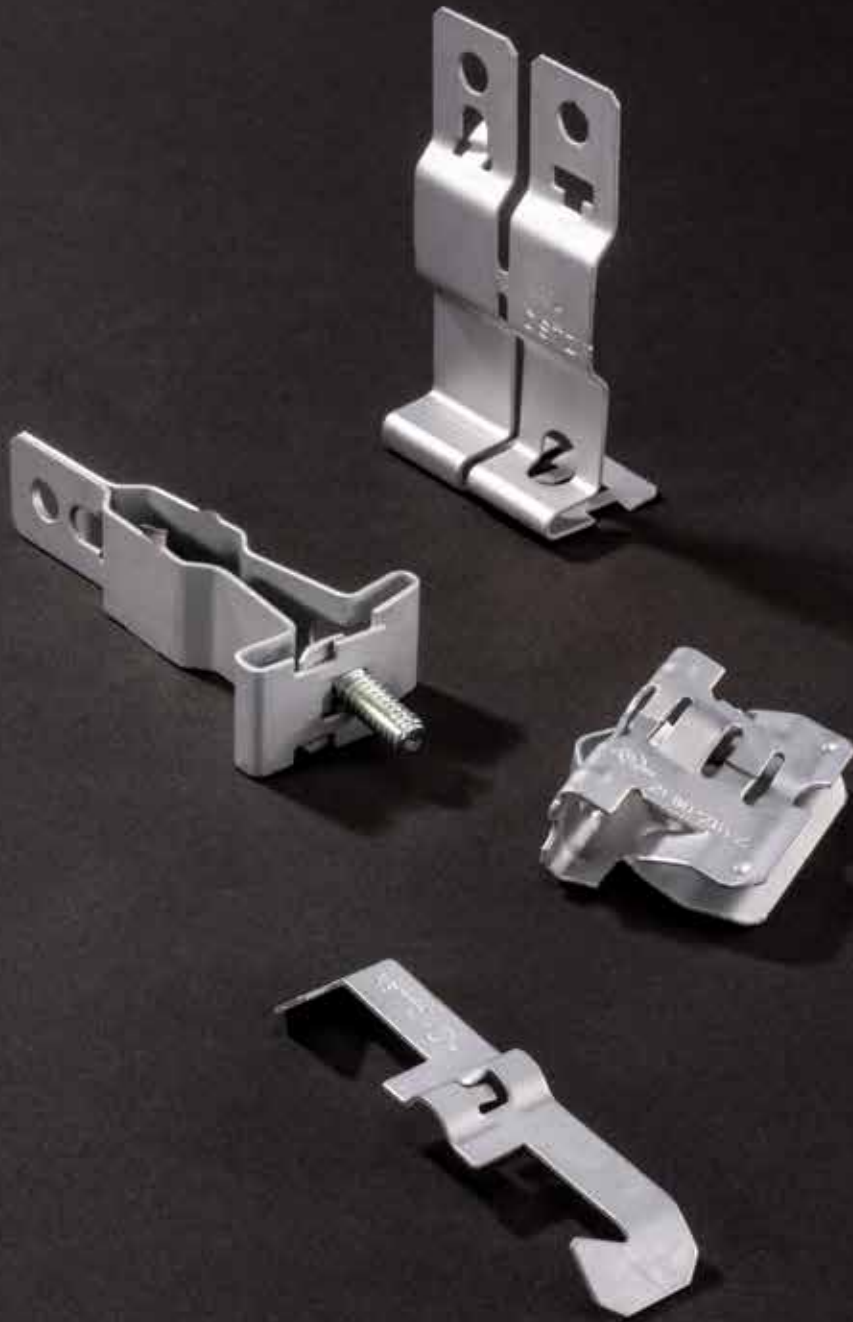

MULTI-PURPOSE SUPPORT CLIP



2FMP28TZ

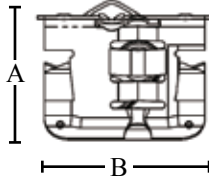

PART #	A	B	C	BOX QTY.
2FMP28TZ	1.44	1.62	.618	100

FEATURES

- Hammer-on attachment
- Fits flanges from 1/8" to 1/2"
- Accommodates 1/4" – 20 or #10 – 24 threaded bridle rings

APPLICATION

- Attaches to flanges to provide an anchor for bridle rings and other hardware

MATERIAL/FINISH

- Spring Steel/GEOSEAL™

CERTIFICATIONS

- UL Standard: UL 2239



TRAY CLIP



KBTTZ

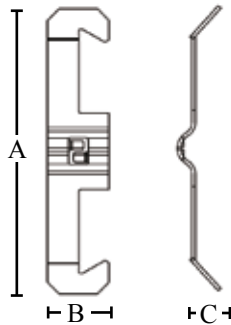

PART #	A	B	C	BOX QTY.
KBTTZ	2.90"	.626"	.295"	100

No load rating, for positioning only.

FEATURES

- Easy no-tool installation
- Supports 3/16" to 5/16" wire

APPLICATION

- Tray Clips attach cable management trays to struts
- Use two clips per strut for a 12" basket and for each additional 6" add another clip

MATERIAL/FINISH

- Spring Steel/GEOSEAL™

CERTIFICATIONS

- UL Standard: UL 2239



ACOUSTICAL/ CEILING

**Fittings that help position electrical
networks to the T-Grid structure**

ELECTRICAL SUPPORT SYSTEMS

FIXTURE SUPPORTS

ELECTRICAL SUPPORT SYSTEMS



THREADED T-GRID CLIP

BOTTOM MOUNT



ATA4ITZ

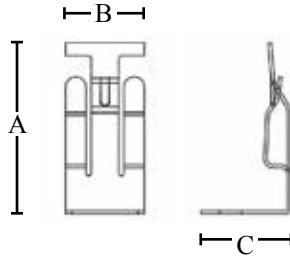

PART #	A	B	C	BOX QTY.
ATA4ITZ	2.14"	.984"	1.12"	100

No load rating, for positioning only. Additional support required per NEC 300.11.

FEATURES

- Easy no-tool installation
- 1/4" threaded hole

APPLICATION

- Threaded T-Grid Clips attach to acoustical T-Bar to provide a method of securing boxes, conduit, or bridle rings

MATERIAL/FINISH

- Spring Steel/GEOSEAL™

CERTIFICATIONS

- UL Standard: UL 2239



THREADED T-GRID CLIP

SIDE MOUNT



ATS4ITZ

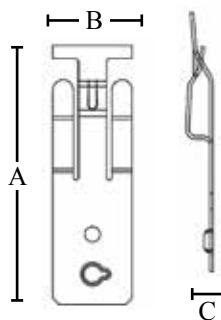

PART #	A	B	C	BOX QTY.
ATS4ITZ	3.20	.984	.374	100

No load rating, for positioning only. Additional support required per NEC 300.11.

FEATURES

- Easy no-tool installation
- 1/4" threaded hole
- Side mount method of hardware attachment

APPLICATION

- Threaded T-Grid Clip attaches to acoustical T-Bar for mounting of boxes, conduit, or bridle rings

MATERIAL/FINISH

- Spring Steel/GEOSEAL™

CERTIFICATIONS

- UL Standard: UL 2239



CONDUIT TO T-GRID SNAP CLAMPS



812MATATZ

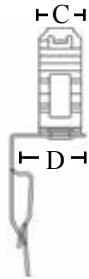
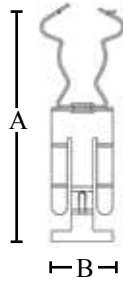

FEATURES

- Easy no-tool installation
- 360° rotating clip
- Top and side mounting available
- Attaches conduit or MC/AC cable to T-Grid

APPLICATION

- Conduit to T-Grid Clamps provide a fast and easy solution to position conduit or MC/AC cables above T-Grids
- Side mount option allows conduit attachment in both the horizontal and vertical directions

MATERIAL/FINISH

- Spring Steel/GEOSEAL™

CERTIFICATIONS

- UL Standard: UL 2239



PART #	MOUNTING OPTION	CLIP CLOSURE	EMT SIZE	MC/AC SIZE	FMC SIZE	A	B	C	D	BOX QTY.
6MATATZ	TOP	SNAP CLOSE	---	14-2 – 12-3	3/8"	3.75"	.984"	.63"	1.12"	100
812MATATZ	TOP	SNAP CLOSE	1/2" & 3/4"	---	---	4.19"	.984"	.63"	1.12"	100

No load rating, this item is for component positioning only. Additional support required per NEC 300.11

CONDUIT TO T-GRID PUSH-IN CLIPS



8PATSTZ



CHPT-50

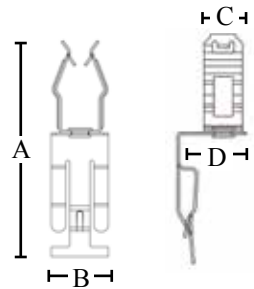
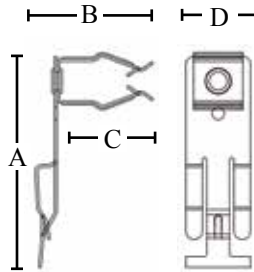

FEATURES

- Easy no-tool installation
- 360° rotating clip
- Top and side mounting available
- Attaches conduit or MC/AC cable to T-Grid

APPLICATION

- Push-in conduit hangers with T-Grid clip snap on the top edge of acoustical ceiling T-bar grid and provide a means of support for EMT conduit above the ceiling tiles

MATERIAL/FINISH

- Spring Steel/GEOSEAL™



PART #	MOUNTING OPTION	EMT SIZE	A	B	C	D	BOX QTY.
8PATSTZ*	SIDE	1/2"	3.20"	1.74"	1.46"	.984"	100
CHPT-50**	TOP	1/2"	3.71	.984"	.748	1.12"	50
CHPT-75**	TOP	3/4"	3.81	.984"	.748	1.12"	50
CHPT-100**	TOP	1"	4.09	.984"	.748	1.12"	50

No load rating, this item is for component positioning only. Additional support required per NEC 300.11

HEAVY DUTY T-GRID BOX HANGER



512HDTZ

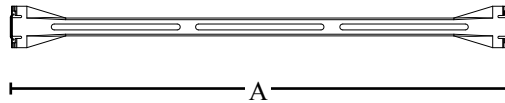

PART #	STATIC LOAD (LBS.)	A	BOX QTY.
512HDTZ	50	24"	25

FEATURES

- No tools required
- Mounts box flush with face of tile
- Mounts 1-1/2" deep box (break off tabs) or 2-1/8" deep box
- Includes mounting clip
- Easily attach drop wire for independent support directly to clip or bar
- Screws into T-Bar for added stability

APPLICATION

- Allows one or multiple electrical boxes to be quickly installed to T-Grid system
- Not for use with paddle fans

MATERIAL/FINISH

- Bar: Steel/Galvanized
- Clip: Spring Steel/GEOSEAL™

CERTIFICATIONS

- UL Standard: UL514A



24" T-GRID BRACKET



BHT1

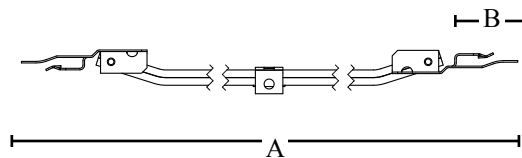

PART #	STATIC LOAD (LBS.)	A	B	BOX QTY.
BHT1	20 LBS. MAX (STATIC)	28.7"	1"	50

FEATURES

- Easy snap-on design

APPLICATION

- Use with boxes 1-1/2" or 2-1/8" Deep

MATERIAL/FINISH

- Galvanized Steel
- Spring Steel

CERTIFICATIONS

- UL Listed

SNAP-ON T-GRID BOX HANGER

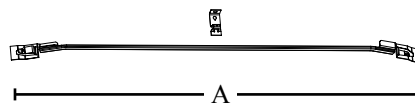
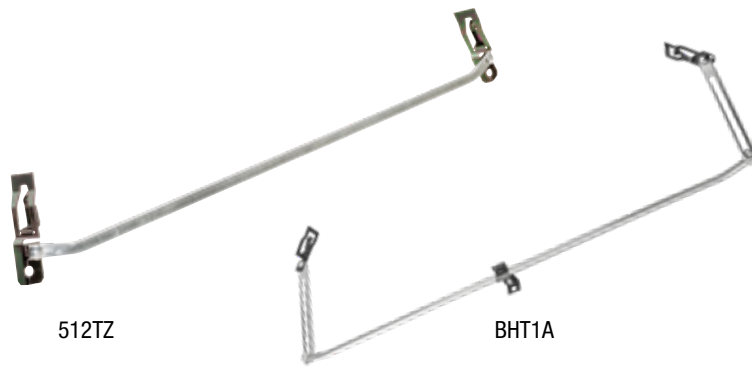

FEATURES

- Snap-on design
- Mounts 1-1/2" or 2-1/8" boxes to T-grids
- Box mounting clip and screw included (see Southwire part BHTC for replacement clip and screw)
- Boxes not included
- Galvanized steel

APPLICATION

- T-Grid brackets are used to mount boxes on ceiling T-bar grid. Fixed length box bar hangers are available for 1-1/2" or 2-1/8" deep boxes

MATERIAL/FINISH

- Bar: Steel/Galvanized
- Clip: Spring Steel/GEOSEAL™

CERTIFICATIONS

- cULus or UL Listed



PART #	(A) LENGTH	HEIGHT ADJUSTMENT	STATIC LOAD (LBS.)	BOX QTY.
512TZ*	24"	NONE	13	25
BHT1A**		1/8" TO 8" ABOVE GRID	13	50
BHT481A**	48"	1/8" TO 8" ABOVE GRID	13	25
BHT1HD**	24"	NONE	50 (RESTRICTED BY GRID)	25

*cULus Listed | **UL listed

Do not exceed static load without independent wire support to box mounting strap

25" LONG RECESS DOWNLIGHT BRACKET



BH3

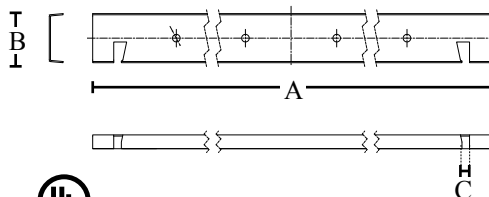

FEATURES

- 25 1/4" straight bracket mounts architectural recess lights,

APPLICATION

- Has notches 24" apart for use on a T-Bar

MATERIAL/FINISH

- Galvanized steel

CERTIFICATIONS

- UL Listed



PART #	A	B	C	BOX QTY.
BH3	25.5"	1.61"	.25"	25 PAIRS

HANGING AND SUPPORT

BHT SERIES BAR HANGERS

CLIP AND SCREW SET



BHTC

FEATURES

- Includes clip and screw

APPLICATION

- Use to affix boxes to Southwire BHT series box support bars

MATERIAL/FINISH

- Steel/Galvanized

PART #	DESCRIPTION	BOX QTY.
BHTC	CLIP AND SCREW, USE WITH BHT1 & BHT1A	50

BH SERIES BAR HANGERS

REPLACEMENT CLIP AND SCREW SET



BHC

FEATURES

- Includes clip and screw

APPLICATION

- Use to affix boxes to Southwire BH series bar hangers.

MATERIAL/FINISH

- Steel/Galvanized

PART #	DESCRIPTION	BOX QTY.
BHC	CLIP AND SCREW	50

BOX SUPPORTS

CEILING

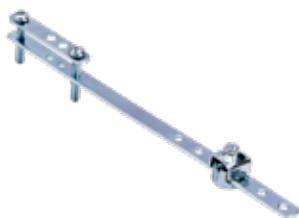

CBS

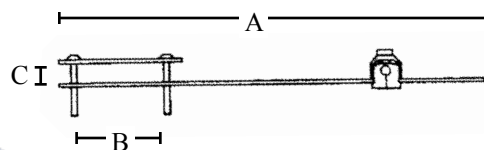

FEATURES

- Robust fabrication ensures continued performance and longevity

APPLICATION

- For installations where space and access may be limited

MATERIAL/FINISH

- Steel

PART #	SIZE	SHIP CASE	WEIGHT/ CASE (LBS.)	A	B MIN	OPENINGS	
						B MAX	C MAX
CBS	1" – 2"	50	16	11"	1"	2.25"	1.25"

T-GRID CEILING 4" SQUARE BOX SLIDER SUPPORT BRACKET

24" LENGTH

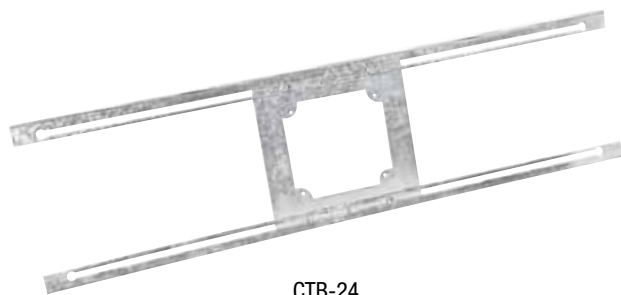

CTB-24

FEATURES

- Brackets rest on back side of ceiling tile and allow box to be installed at any position required
- Mounting plate accommodates all 4" boxes and covers
- "LK" suffix locking bracket design reduces movement due to vibration
- Some assemblies include boxes (see below)

APPLICATION

- Ceiling tile slider brackets are used to mount a variety of electrical and electronic components on ceiling grid tiles

MATERIAL/FINISH

- Steel/Galvanized

PART #	DESCRIPTION	LOCKING TABS	BOX INCLUDED	BOX QTY.
CTB-24	ADJUST 4" BOX ANYWHERE ALONG 24" BRACKET	NO	---	20
CTB-244S	ADJUST 4" BOX ANYWHERE ALONG 24" BRACKET WITH 4" SQUARE BOX	NO	52181-S	20
CTB-24LK	ADJUST 4" BOX ANYWHERE ALONG LOCKING 24" BRACKET	YES	---	20
52181-VTBAR	4" SQUARE, 3-1/2" DEEP BOX, HORIZONTAL & VERTICAL BRACKET ADJUSTMENT	SCREWS	52181-VT	10

T-GRID CEILING, 3" X 2" SWITCH BOX SUPPORT BRACKET



DCB

FEATURES

- Mounts anywhere along grid opening
- Switch box ears mount directly to bracket

APPLICATION

- Bracket is used to secure a 3" x 2" switch box to T-Grid ceiling
- Perfect for mounting small life safety appliances, security cameras or standard outlets

MATERIAL/FINISH

- Steel/Galvanized

PART #	DESCRIPTION	BOX QTY.
DCB	SECURES 3" X 2" WITH EARS TO SECURE TO DROP CEILING GRID	25

FIXTURE SUPPORTS



TWIST CLIP



4G16HTZ

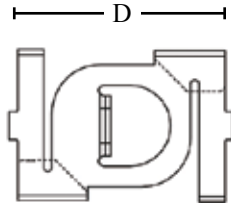
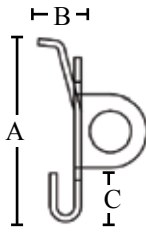

FEATURES

- Easy no-tool installation
- Plain hole

APPLICATION

- Twist clips are easily installed with no tools and provide a solution to support wire, hooks, or chains from T-Grids

MATERIAL/FINISH

- Spring Steel/GEOSEAL™

CERTIFICATIONS

- UL Standard: UL 2239



PART #	T-GRID SIZE	HOLE SIZE	STATIC LOAD (LBS.)	A	B	C	D	BOX QTY.
4G16HTZ	15/16"	1/4" – PLAIN	40	1.094"	.65"	.433"	1.60"	100

TWIST CLIP WITH WING NUT



4G16TZ

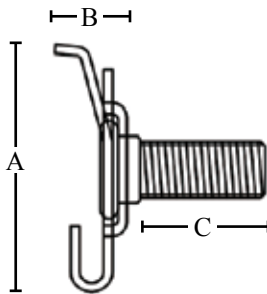

FEATURES

- Easy no-tool installation
- Wing Nut included

APPLICATION

- Twist clips with wing nut are designed to support electrical fixtures from T-Grids and are easily installed with no tools

MATERIAL/FINISH

- Spring Steel/GEOSEAL™

CERTIFICATIONS

- UL Standard: UL 2239



PART #	T-GRID SIZE	SCREW LENGTH	THREAD SIZE	STATIC LOAD (LBS.)	A	B	C	BOX QTY.
4G16TZ	15/16"	9/16"	1/4" – 20	50	1.09"	.256"	.728"	100

LIGHT FIXTURE CLIP



515ATZ

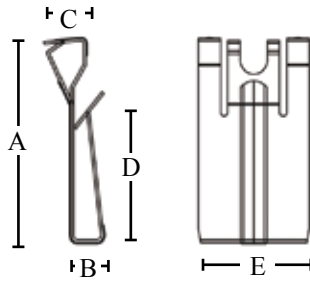

PART #	A	B	C	D	E	BOX QTY.
515ATZ	1.81"	.291"	.371"	1.34"	.984"	100

FEATURES

- Easy no-tool installation

APPLICATION

- The Light Fixture Clip provides a method for securing troffers, lay-in fixtures along with air diffusers

MATERIAL/FINISH

- Spring Steel/GEOSEAL™

CERTIFICATIONS

- UL Standard: UL 2239



FIXTURE TO T-GRID CLIP



IDSTZ

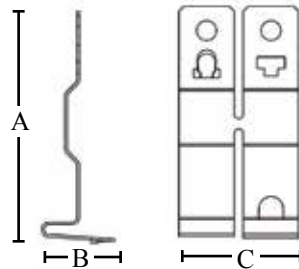

PART #	T-GRID SIZE	STATIC LOAD (LBS.)	A	B	C	BOX QTY.
IDSTZ	15/16"	65	3.10"	.979"	.748"	100

FEATURES

- Easy no-tool installation
- Includes mounting hardware

APPLICATION

- Clips easily to T-Grid with no tools to support fixtures

MATERIAL/FINISH

- Spring Steel/GEOSEAL™

CERTIFICATIONS

- UL Standard: UL 2239



JACK CHAINS



770TZ

FEATURES

- 12 Gauge Steel 770TZ & W-13
- 10 Gauge Steel W-10

APPLICATION

- Support chain for hanging linear and high bay fixtures

MATERIAL/FINISH

- Steel/Zinc plated

PART #	STATIC WORKING LOAD (LBS.)	PACK SIZE	INNER QTY.	MASTER QTY.
W-10	43	100 FT. BOX	100	500
770TZ	29	100 FT. BOX	100	400
W-13	29	50 FT. BOX	50	500
298S	29	100 FT. ROLL	100	400

S-HOOKS



W-11

APPLICATION

- Use to attach accessories to Jack Chain

MATERIAL/FINISH

- Steel/Zinc plated

PART #	SIZE	STATIC LOAD (LBS.)	INNER QTY.	MASTER QTY.
300	1"	16	100	1000
300A	1-1/4"	29	100	1000
300B	1-1/2"	43	100	1000
W-11	3"	50	100	1000



Southwire™

HANGING & SUPPORT CATALOG

get social with us:



[/SOUTHWIRETOOLS](#)



[/SOUTHWIRE-COMPANY](#)



[@SOUTHWIRETOOLS](#)



[@SOUTHWIRE](#)



SCAN TO LEARN MORE

WWW.SOUTHWIRE.COM | 1-855-SWT00LS

All Trademarks or Registered Trademarks (TM/®) are owned or licensed by Southwire Company.
Any other TM/®- Trademark or Registered Trademark of Southwire Company.